

Comparison of Thin-Film and Wire-Wound Heaters for Transparent Applications



Table of Contents

Abstract	Page 3
Why Heat an LCD display?	Page 3
Physical Properties	Page 3
Watt Density	Page 4
Resistance Tolerances	Page 4
Resistance Repeatability and Stability	Page 4
Electrical Connections	Page 5
Conductive Elements	Page 5
Heater Shape	Page 5
Varying Power Density	Page 6
Resistance	Page 6
Comparison Chart	Page 7
Summary	Page 7

Abstract

Warming an LCD display, glass plate or test chamber window to enhance visibility creates difficult design problems. Flexible heaters with silicone rubber or polyimide insulation block light, making viewing through the material impossible. Heating only around the edges with a larger cartridge style heater or opaque flat heater may not provide enough heat to warm the entire surface, or may lead to temperature gradients that can fracture glass. The solution is a clear heating element that can provide heat to the entire surface. Two types of clear heaters are commonly used - thin-film Indium Tin Oxide (ITO) and optically clear polyester wire-wound. This study compares how the intrinsic qualities of each of these heater types can influence visibility.

Why Heat an LCD Display?

LCD displays in instruments and machinery may be exposed to extreme temperatures, and the response rate of the LCD decreases as the temperature drops. Many manufacturers rate their LCD displays to 0°C (32°F) minimum operating temperature. Operating below the rated temperature may cause the LCD to react very slowly or show meaningless characters. These critical environment situations require a fast acting display while operating at temperatures in -40°C or colder.

The solution to keeping the devices working in cold temperatures is to heat the display. Wire or etched element heaters with opaque insulation can be bonded to the LCD, but if the display has electroluminescent, LED or fluorescent backlighting, the heater must allow light transmission.

Physical Properties

Thin-film Indium Tin Oxide (ITO) is constructed with a very thin coating of metal film deposited on a polyester sheet (Figure 1). This film is generally transparent to visible light, with an electrical resistance that provides heat when powered.

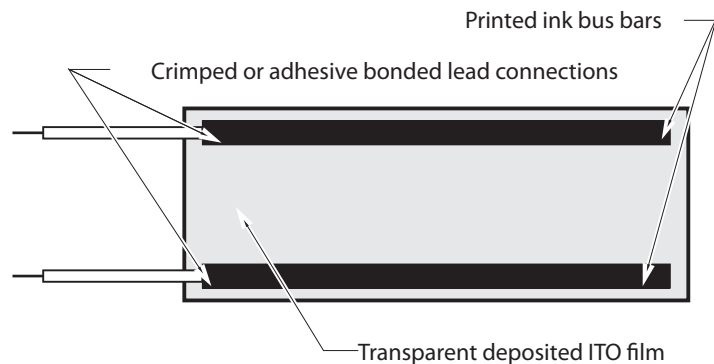

Figure 1: Thin-film ITO heater

A wire-wound heater is constructed with a small diameter resistive wire, typically about 25 μ (0.001 inch) diameter, laid in a pattern between two sheets of optically clear polyester (Figure 2).

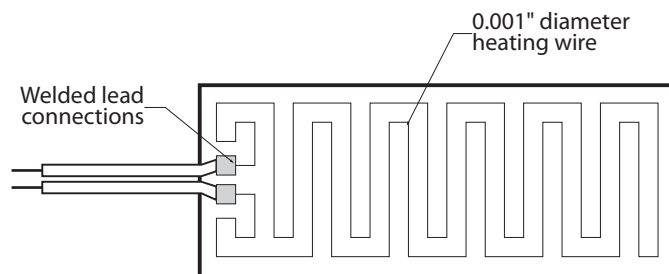

Figure 2: Wire-wound heater

Watt Density

Wire-wound heaters deliver uniform watt density (heat flux) across the entire heater area (Figure 3).

Since electrical current travels the path of least resistance, the watt density in ITO heaters decreases with distance from power connection points. This is due to the voltage drop along the length of the bus bars.

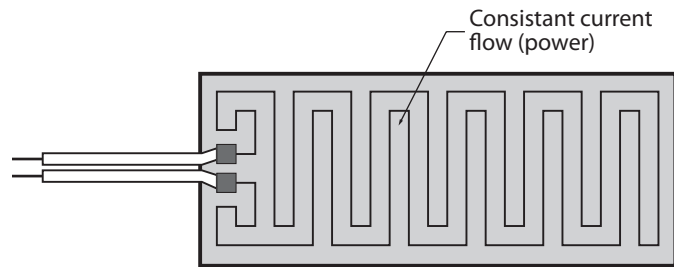

Figure 3

The heating profile is shown (Figure 4) with darker shading representing higher watt density.

This effect can be minimized by reducing the resistance in the bus bars. One method is widening the bus bars. However, this increases the non-heated zones of the heater and reduces viewing area.



Figure 4

A second method is to attach leadwires on both ends of the bus bars to effectively cut the resistance in half (Figure 5):

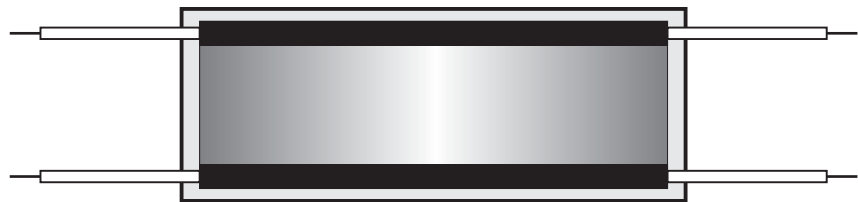

Figure 5

Resistance Tolerances

Wire-wound heater resistance tolerances start at $\pm 10\%$ standard and can be built down to $\pm 2\%$.

ITO heaters have resistance tolerances of $\pm 20\text{-}25\%$ and cannot be tightened. The tolerance depends on the uniformity of the ITO coating. The smallest variation in thickness will have a substantial effect on resistance. Most ITO vendors specify $\pm 20\%$ due to this variability. Resistance shifts can also occur during manufacturing, so the final product must have an even wider tolerance. If the device is battery powered $+25\%$, resistance may not provide enough heat and -25% will reduce battery life.

Resistance Repeatability and Stability

Repeatability tells how steady the resistance readings are at the same temperature. Stability is the absence of long term shift.

Some ITO heater users have seen a resistance shift over time and even from cycle-to-cycle. Resistance instability can result in erratic heating and power draw.

The repeatability and stability of a wire-wound heater is similar to wire-wound resistance thermometers. Ordinary industrial models will drift less than 0.1% per year in normal use.

Electrical Connections

A wire-wound heater has all electrical connections welded together to ensure reliable connections.

ITO heater bus bars are made of a thin screen printed layer of conductive ink. Terminations to pins or hook-up wires are done by mechanically crimping the materials together or bonding the terminal to the conductive ink.

Conductive Elements

A wire-wound heater consists of fine wire elements. To achieve the required design resistance density, different wire sizes, materials and spacing can be used. Since such a small percentage of the overall heater area is covered by the fine wire, the effect on light transmission is minimal.

An ITO heater consists of a thin layer of ITO. To get lower resistances, a thicker layer of ITO is needed. This can lower the light transmission to less than 75%. ITO heaters with very high resistance are the clearest. Many transparent heater applications are battery operated and require a very low resistance heating area, resulting in lower light transmission.

The ITO layer is very thin (1000 Å typical). A scratch or a light sweep of a static brush to clean the surface of dust can fracture the coating. Electrical current crowds around the edges of any fracture in the ITO coating resulting in a hot spot. Once initiated, this hot spot will propagate across the heater until the electrical circuit becomes open.

Heater Shape

A wire-wound heater can be designed to any shape with uniform watt density (Figure 6).

Watt density in an ITO heater becomes less uniform with non-rectangular heaters or non-parallel bus bars. Changing distance between bus bars will change the wattage profile. Again, the figure below (Figure 7) shows higher wattage as darker shading.

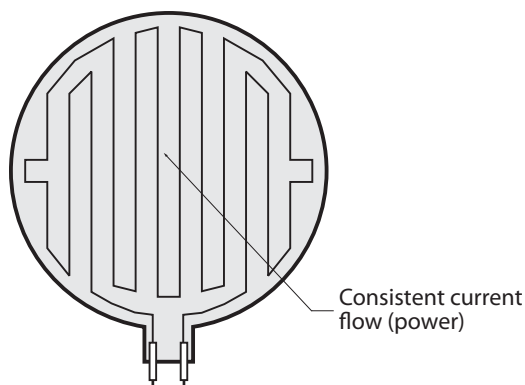

Figure 6

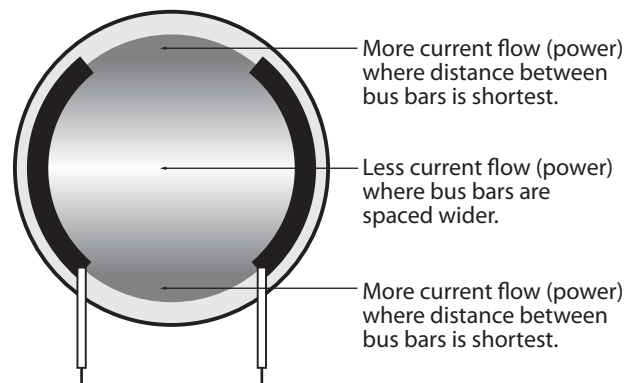

Figure 7

Varying Power Density

A unique option with wire-wound heaters is the ability to design the heater for extra power precisely where it is needed. For example, an LCD often loses more heat around the edges where the mounting bracket acts like a heat sink. By varying the distance within the wire pattern it is possible to put just enough extra heat on the edges to compensate. This is often referred to as "profiling" the watt density. The result is optimum temperature across the entire surface, without adding excess heat (Figure 8).

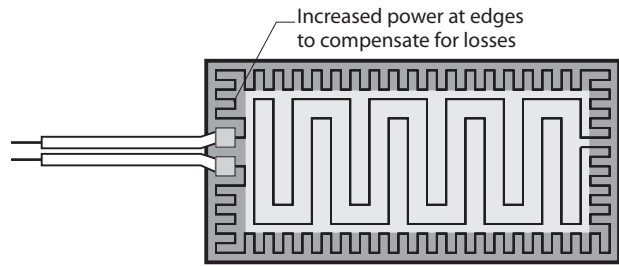

Figure 8

Resistance

Wire-wound heaters can be designed to any resistance by adjusting element wire material and/or the diameter of the element wire.

ITO heater resistance is based on the base resistance of the coating and shape (not size) of the heater (Figures 9 and 10).

$$\text{Resistance} = \frac{(\text{distance between bus bars}) \times (\text{resistivity})}{(\text{length of bus bars})}$$

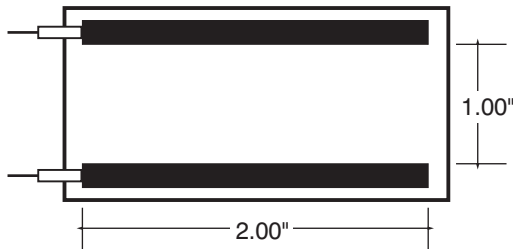

Figure 9

$$\text{Resistance} = \frac{(1 \text{ in.}) \times (60 \Omega)}{(2 \text{ in.})} = 30 \Omega$$

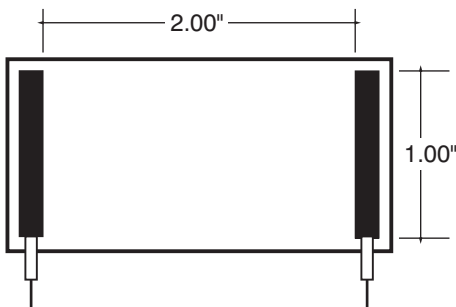

Figure 10

$$\text{Resistance} = \frac{(2 \text{ in.}) \times (60 \Omega)}{(1 \text{ in.})} = 120 \Omega$$

For instance, assume you have an ITO coating with a resistivity of 60 Ω/square inch. A 1" × 1" heater would have 60 Ω. And a 2" × 2" heater would have 60 Ω. Consider each 1" square as a resistor of resistance R and use Kirchhoff's Current Law for series/parallel resistance circuits (Figures 11 and 12 on the next page):

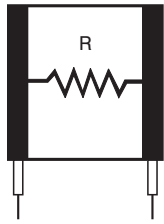

Figure 11

Resistance = R

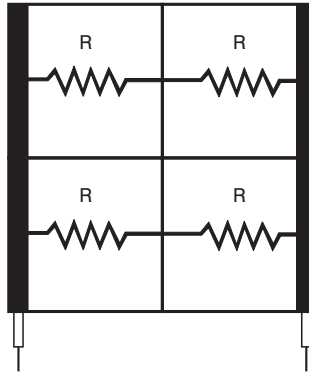

Figure 12

$$\frac{1}{\text{Resistance}} = \frac{1}{R+R} + \frac{1}{R+R} = \frac{2}{2R} = \frac{1}{R}$$

Resistance = R

Comparison of Optically Clear Polyester Wire-wound Heaters to Typical ITO Heaters

Characteristic	Optically clear polyester wire-wound heaters	ITO film heaters
Light transmission	Excellent (>82% of visible light).	Good (up to 75% of visible light, less for very low resistance films).
Transparent area	Light transmission edge to edge. Leadwire attachment can be on external tab outside of viewing area.	Bus bars intrude on viewing area. Locating power connections on external tabs increases power loss in bus bar areas.
Light obstruction	The small diameter heating wire may create shadows on the display.	Consistent clarity - no shadows or disruptions of light.
Resistance tolerance	±10% standard, to ±2% at higher cost.	±20 to 25%.
Resistance range	Any value to 3000 Ω / in ² (lower limit may depend on wire used).	Usually 2 to 4 options available within 5 to 100 Ω /square range.
Outline shape	Any two-dimensional shape possible.	Rectangle only to ensure most consistent watt density.
Power uniformity	Output power proportional to resistance density across the heater.	Wattage decreases with distance from power connection points due to bus bar resistance.
Power profiling to compensate for edge losses	Controlled and repeatable power density profiling available within any heater shape.	No power profiling.
Maximum power density	Up to 10 watts/in ² for fast warm-up; typical applications require 1 watt/in ² to maintain temperature.	Can be damaged at greater than 2-3 watts/in ² .
Maximum temperature	Up to 120°C.	Up to 100°C.
Leadwire connections	Welded connections with strain relief for maximum strength.	Mechanically crimped or epoxy bonded wires.
Integrated sensor options	Point sensor or flat, averaging RTD sensors available.	Point sensor only.
Control options	Use a sensor with electronic control or a heaterstat sensorless controller.	Use sensor with electronic control.

Summary

The reason for choosing a thin-film or wire-wound heater is clear. Cold temperatures can severely limit the visibility of electronic displays. But there are important differences between these two options to consider. Watt density and resistance repeatability and stability are more consistent in a wire-element heater regardless of shape or size of the display. Wire-wound heaters also make it easier to achieve the required design resistance for optimal light transmission. Plus, a unique option of a wire-wound heater is the ability to design the heater for extra power precisely where it is needed.

Worldwide Headquarters
7300 Commerce Lane
Minneapolis, MN 55432 USA
Tel: 1.763.571.3121
Fax: 1.763.571.0927
sales@minco.com
www.minco.com

European Headquarters
Usine et Service
Commercial, Z.I.
09310 Aston, France
Tel: (33) 5 61 03 24 01
Fax: (33) 5 61 03 24 09

Asia Pacific Headquarters
20 Science Park Road
#02-31 Teletech Park
Singapore Science Park II
Singapore 117674
Tel: (65) 6511 3388
Fax: (65) 6511 3399

ISO 9001:2000
© Minco 2008

**MINCO**

A critical component of your success™

Flex Circuits
Thermofoil™ Heaters
Sensors
Instruments