

# MINCO CT124

## 8-Channel Temperature Monitor

---

### INSTRUCTION MANUAL

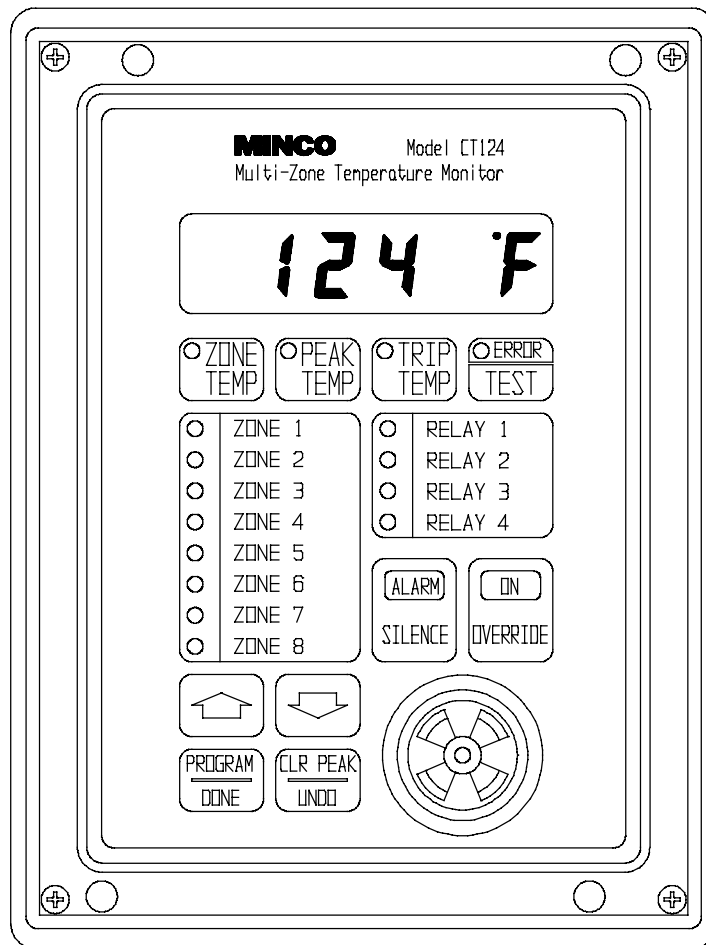

*When quality and performance are as important as price, call...*

**MINCO** PRODUCTS, INC.

7300 Commerce Lane/Minneapolis, Minnesota 55432-3177 U.S.A.

Telephone:(763)571-3121

FAX:(763)571-0927

FORM #930616-1

This page left blank

## CONTENTS

SAFETY .....	2
GENERAL DESCRIPTION .....	3
INSTALLATION .....	4
MOUNTING .....	4
WIRING .....	5
CHANGING FRONT PANEL LABELS .....	9
OPERATING INSTRUCTIONS .....	10
PROGRAMMING INSTRUCTIONS .....	12
TROUBLESHOOTING .....	18
ERROR MESSAGES .....	18
CALIBRATION .....	20
RETURN FOR REPAIR .....	21
SPARE PARTS LIST .....	21
SPECIFICATIONS .....	22
MODEL NUMBER CODING .....	23

## **SAFETY**

1. Dangerous high voltages are present inside the case. Always cut power to the controller before opening the front cover. Installation of a nearby power cutoff switch is recommended.
2. Contact Minco before attempting any repairs.
3. Do not remove the CT124's rear cover. Access the inside by removing the front cover only.
4. Many components may be damaged by static discharge. Do not touch electrical connections inside the case. Handle plug in cards only by their edges or at a static-free workstation.
5. Never unplug the ribbon cable inside the enclosure while power is applied. Permanent damage may result.

## GENERAL DESCRIPTION

The CT124 8-Channel Temperature Monitor offers flexible protection and control of temperature-critical equipment and processes. It scans up to eight RTD's and activates four relays plus a built-in audible alarm.

In a typical application, the CT124 provides early warning of possible large machine failure by monitoring the temperature of bearings, stators, transformer coils, and oil outlets. You can configure the CT124 to many other situations such as on/off control or under-temperature alarms. The CT124 can even monitor and control several loops at one time since you can group input zones with output relays in any combination.

### Features:

- Protect motors, generators, transformers, and other equipment.
- Monitor 1 to 8 resistance temperature detectors (RTD's).
- 4 internal relays and audible alarm with independent trip points.
- Over-temperature or under-temperature protection.
- Microprocessor based; fully programmable.
- Large, bright LED display shows °F or °C.
- Stores high and low temperature peaks.
- Trip points, programs, and peaks stored in non-volatile memory.
- Programmable silence button.
- Versatile override switch permits manual relay toggling.
- Rugged enclosure with sealed front panel.

## INSTALLATION INSTRUCTIONS

### MOUNTING

1. Choose a mounting location which meets these conditions:
  - Operating ambient temperatures must be within 0 to 55°C (32 to 131°F).
  - Air must be free to circulate around the sides and rear of the case.
  - The front panel is sealed against dust and moisture. The sides and rear must be protected from water and excessive dust inside a suitable enclosure.
  - Do not use the CT124 in hazardous (explosive) atmospheres.
  - Do not expose the CT124 to continuous or excessive shock and vibration.
  - Mount the CT124 at any angle.
  
2. Cut a rectangular hole in your panel according to the dimensions shown in Figure 1.

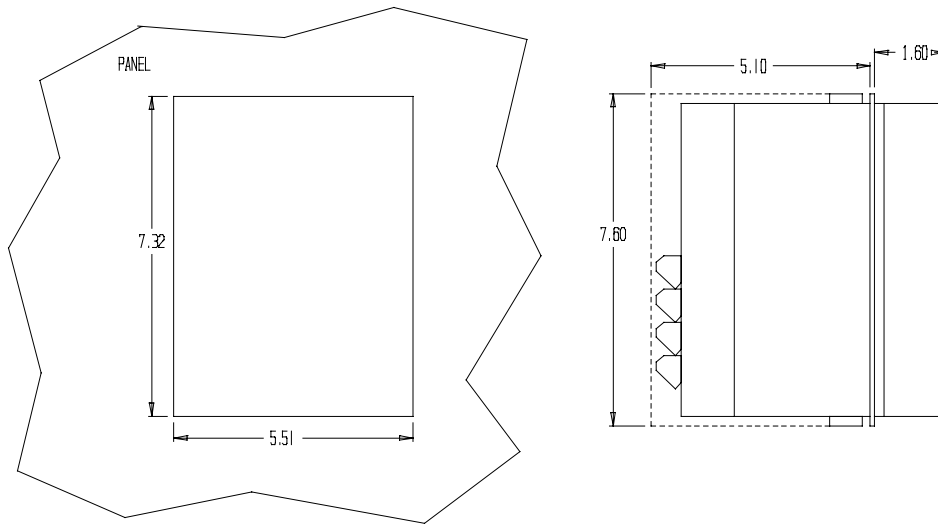

**Figure 1** Panel Cutout Dimensions (in inches)

3. Place the controller into the panel hole. Using a Phillips screwdriver with a shaft diameter less than 1/4" (6.3 mm), tighten the four clamping screws shown in Figure 2.

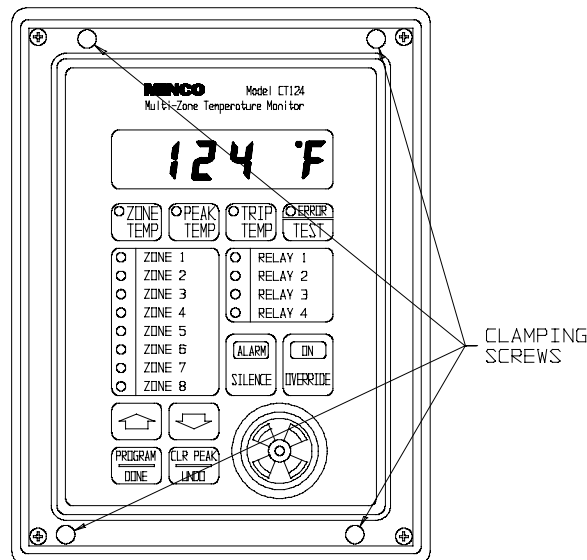

**Figure 2** Clamping Screw Access Locations

## INSTALLATION

### WIRING

Carefully read the following wiring instructions before routing the power and signal (RTD) wires to the CT124. You must observe these guidelines in order to ensure safe, accurate, and stable operation.

No special terminals are required; just strip all wires 1/4". Maximum wire size is 14 AWG.

You may find it more convenient to unscrew the two connector boards from the rear of the case and remove them while you are connecting the wires. In the event that the CT124 must be returned to Minco for repair, simply disconnect the connector boards and leave the wires attached to the terminal blocks.

#### Power Supply Wiring

##### 115/230 Volt Version (Standard):

The controller is factory set for 115 VAC operation. A switch inside the case cover selects optional 230 VAC. After reading the precautions on page 2, remove the front cover. Set the switch on the right most circuit board to 230 VAC (see Figure 3). Replace the cover.

Installation of an external power switch or circuit breaker is strongly recommended for safety and serviceability. To replace internal fuses the power must be turned off. Also, dangerous voltages are within easy reach if the front panel is removed while power is on.

The CT124 is internally fused with two .315 amp fast-blow fuses (5 x 20 mm). External fusing is not necessary. The fuses are located on the power supply board (rightmost circuit board). The board must be removed to replace the fuses.

Connect power to the Line Input terminals of the power line filter on the back of the CT124. See Figure 4 for details. Use the 1/4" quick connect terminals provided.

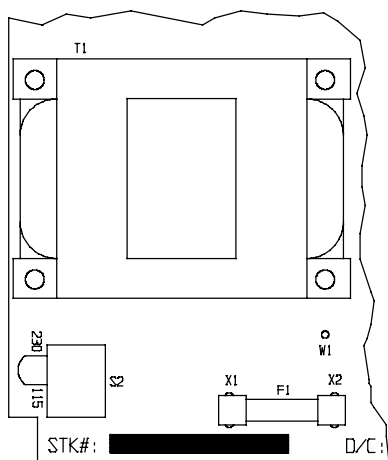

**Figure 3** Switch Location for 115/230 VAC Operation

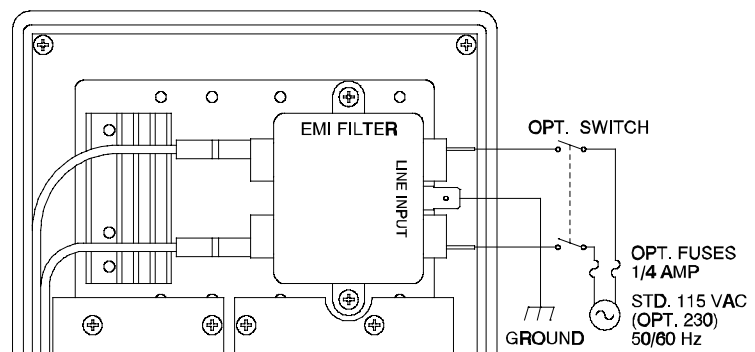

**Figure 4** AC Power Wiring Diagram

##### 24 Volt DC Version:

As shown in Figure 5, connect the 24 volt positive lead to terminal 1 of the power terminal block, the negative lead to terminal 2, and chassis ground to terminal 3.

# INSTALLATION

An external power cut-off switch is not needed for safety, but would be useful if servicing inside is needed at a later date.

The 24 VDC version is internally fused with a single .315 amp fast-blow fuse (5 x 20 mm). External fusing is not necessary.

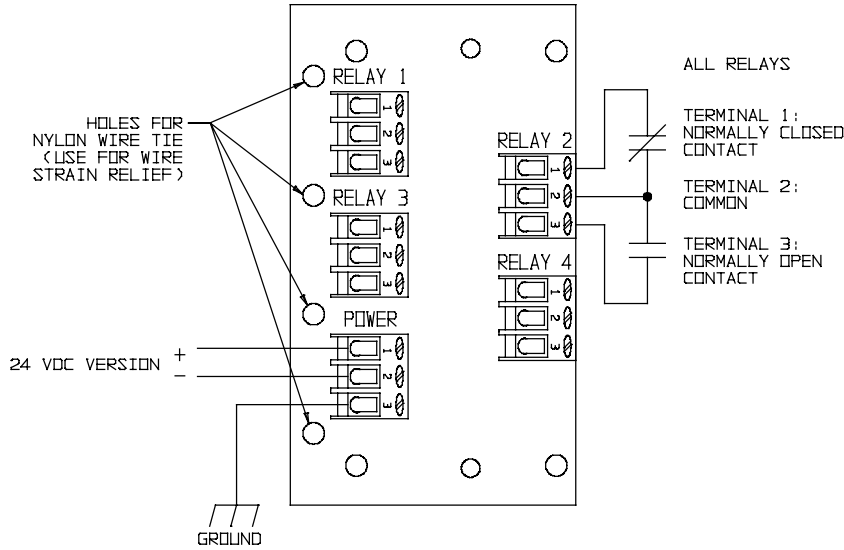

**Figure 5** Relay Wiring Diagram

## Relay Wiring

The relay connector board is labelled with normally open and normally closed contact symbols. This corresponds to the unpowered or "normal" acting operating state of the relays.

In certain applications you may want the relays to be "reverse" acting. This means that if the CT124 loses power, the relay(s) will de-energize into the tripped or alarm state. See Figure 6 for a summary of relay states.

Relay Actions	Terminal Positions	
	1-2	2-3
<b>NORMAL ACTING</b>		
Power on - untripped	Closed	Open
Power on - tripped	Open	Closed
Power off	Closed	Open
<b>REVERSE ACTING</b>		
Power on - untripped	Open	Closed
Power on - tripped	Closed	Open
Power off	Closed	Open

**Figure 6** Relay States

You can set any of the 4 relays for reverse action with dip switch S1 located on the top of the power supply (right-most) board inside the case (Figure 7). Read the safety precautions on page 2 before removing the cover.



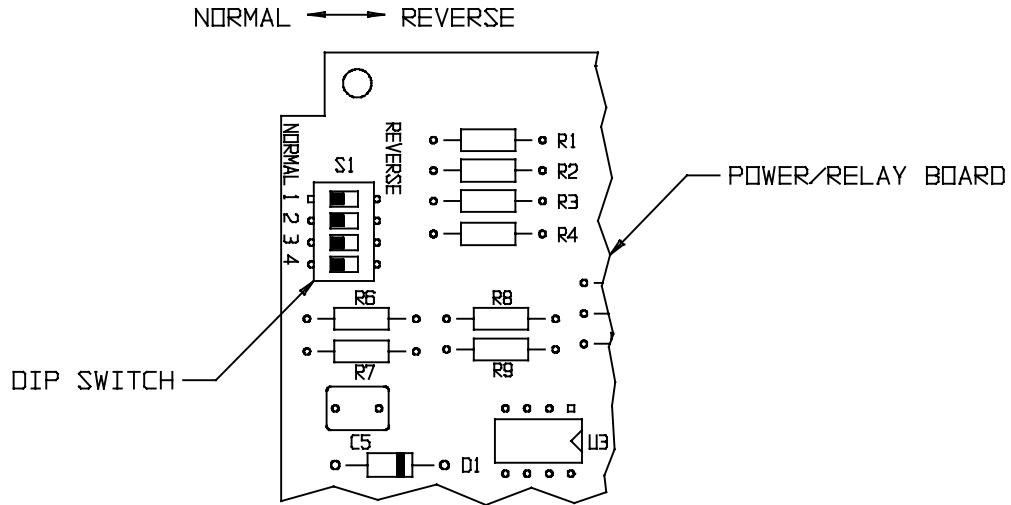

**Figure 7 Dip Switch Location**

**RTD Wiring**

Avoid routing RTD wires along with or near electrically noisy wires such as wiring to contactors, motors, computers, etc. Electrical interference from these wires may cause instability or shifts in the CT124's readings. For best noise immunity, use twisted and shielded extension leadwire to the RTD's.

The RTD wires and sensing element must be insulated from ground potential and all other voltages. Be sure the dielectric strength rating of the RTD exceeds the voltage it will see in use, especially when mounted in electric machinery.

Figure 8 shows RTD wiring. For 3-lead RTD's, connect the 2 leads of the same color to TB2 and TB3, the odd lead to TB1. Connect 2-lead RTD's to TB1 and TB2 with a shorting jumper wire from TB2 to TB3. Connect shields to TB4.

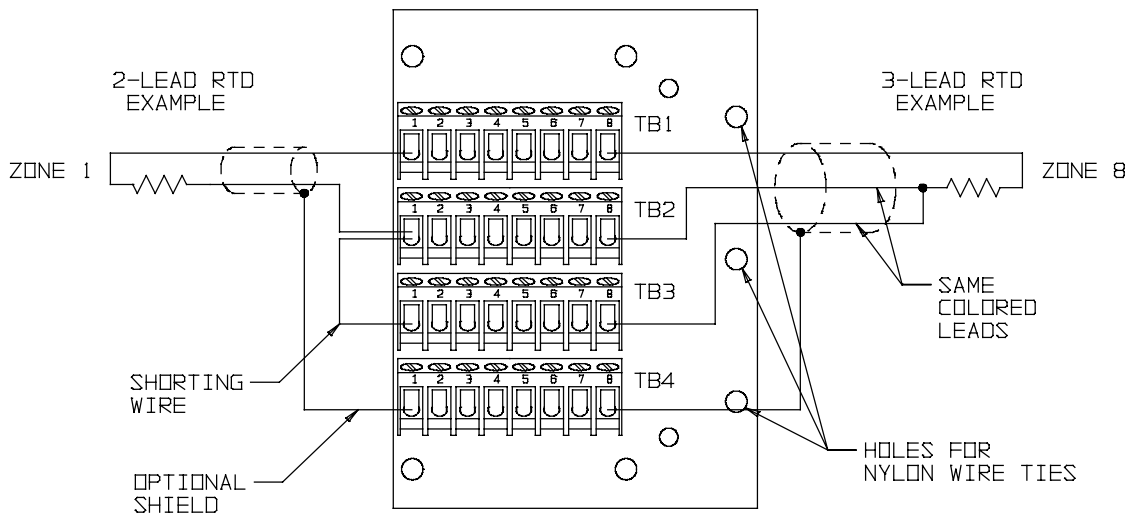

**Figure 8 RTD Wiring Diagram**

Secure all wires to the connector boards with nylon cable ties in the holes provided.

## INSTALLATION

The CT124 will automatically cancel the effects of long lead wires with up to 10 ohms of leadwire resistance when used with 3-lead RTD's. Knowing the size and length of the RTD's leads, we can estimate the resistance. Figure 9 lists the size of wires, their resistance per foot at 25°C, and the maximum length each leadwire can be for 10 ohms of resistance. For proper leadwire cancellation, each lead must have exactly the same resistance. For example, a difference of 1 ohm can mean more than 2.5°C (4.6°F) error for a 100 Ω platinum RTD, or more than 26°C (47°F) error for a 10 Ω copper RTD.

Leadwire (AWG)	Ohms/Foot at 25°C	Maximum Length for 10 Ohms of Resistance
18	0.0065 Ω/ft.	1538 ft.
20	0.0103 Ω/ft.	971 ft.
22	0.0165 Ω/ft.	606 ft.
24	0.0262 Ω/ft.	382 ft.
26	0.0418 Ω/ft.	239 ft.
28	0.0666 Ω/ft.	150 ft.

**Figure 9** Leadwire Resistance Chart

### Alternative RTD Wiring Options

For the best accuracy, all 3 leads of each RTD should be brought to the CT124 as shown in Figure 8. However, with some high voltage electric motors, the RTD's have been prewired to a terminal block with one of the common leads for each RTD grounded. Unless required for safety reasons, this should be rewired with 3 individual leads for each RTD to the CT124.

Figure 10 shows 2 alternative wiring methods. With either method, ground loop currents may cause erratic readings. If so, remove the ground connection to the CT124's power input terminal block. Note that option B does not provide 3-lead compensation.

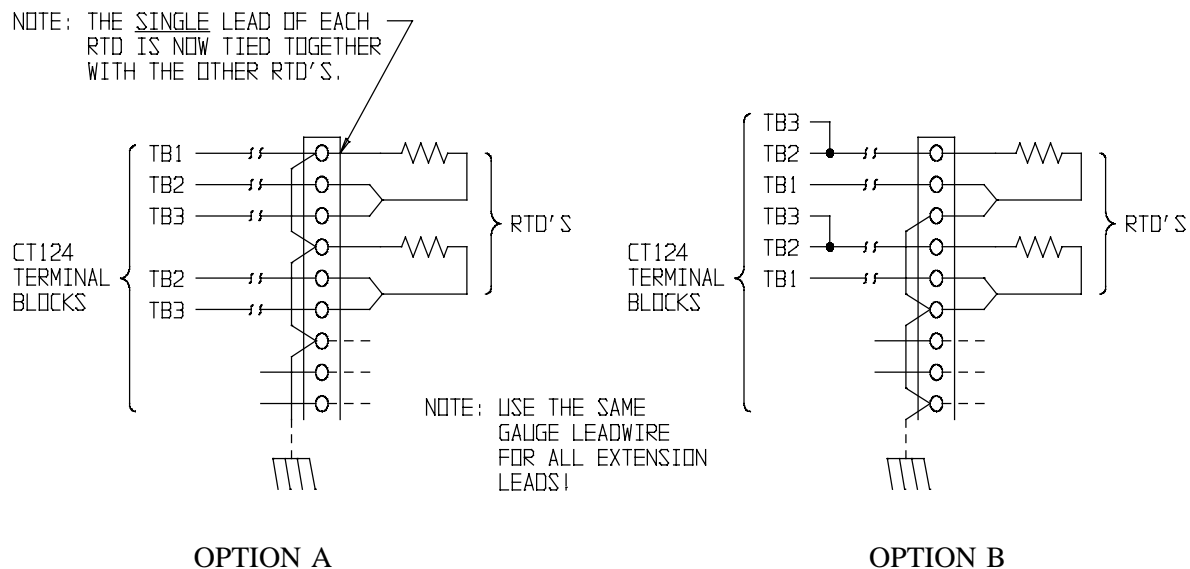

**Figure 10** Alternative RTD Wiring Options

## INSTALLATION

### CHANGING FRONT PANEL LABELS

If you wish, you can replace the zone and relay labels on the front panel of the CT124. Follow these instructions:

1. Follow the safety precautions on page 2. Be sure power is off, then remove the CT124's front panel and disconnect the ribbon cable.
2. Remove the 2 spade lugs from the built-in alarm inside the front panel. Remove the 8 screws holding the circuit board in place. To avoid damage from static electricity, do not touch conductors while handling the circuit board. Remove the circuit board.
3. Pull out the old zone and relay labels. Write your descriptions in the blank forms located in the back of this manual. Cut out, fold, and insert into the slots in the CT124's faceplate.
4. Replace the circuit board and screws, reconnect the alarm and ribbon cable, and reinstall the front cover.

## OPERATING INSTRUCTIONS

### GENERAL OPERATION

The CT124 Multi-Zone Temperature Monitor continuously scans temperature input from 1 to 8 RTD's (Resistance Temperature Detectors). It compares each reading to 5 separate trip points and activates relays and a built-in alarm when any RTD senses an over- or undertemperature condition. The audible alarm may be set to go off when any of the four relays are tripped, and/or independently at its own trip point. Setting up the trip point temperatures and the actions of the relay and alarm outputs to input conditions is covered in the Programming Instructions (see page 12). The following instructions describe the general operation after programming is completed. We recommend that the operator have a copy of the completed **CT124 Setup Worksheet** at hand for a complete description of the programmed operation.

Note: Viewing the zone, peak, or trip temperatures will not interrupt input scanning. However, input scanning is interrupted and outputs remain unchanged while in the test and programming modes.



### ZONE TEMPERATURES

Depending on its program, the CT124 normally displays:

- The highest temperature sensed by an RTD, or
- The lowest temperature sensed by an RTD, or
- Any zone temperature selected for display.

To view zone temperatures:

Press . The red light at the upper left corner of the button comes on.

Press  or  to see different zones. The light beside each zone comes on as it is displayed.

 indicates the CT124 is not programmed to scan that zone.

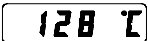

example:  with zone 2 lit indicates that input RTD 2 is sensing 128°C.

### PEAK TEMPERATURES

The CT124 stores both high and low peak temperatures in each monitored zone.

To view peak temperatures:

Press . The red light at the upper left comes on.

Press  or  to see alternate high-low peaks for each zone.

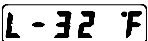
example:  with zone 3 lit indicates a low point of -32°F sensed by input RTD 3.

 indicates a high peak of 150°F.

To clear peak temperatures:

Press  while viewing a peak temperature to clear it. The current temperature in that zone becomes the new peak and the display advances.



## OPERATION

### TRIP TEMPERATURES

The CT124's four relays and single audible alarm may be programmed to trip on either overtemperature or undertemperature conditions.

To view trip temperatures:

Press . The red light at the upper left of the button comes on.

Press  or  to cycle through the relays and alarm. The specific relay or alarm light will blink to show which trip temperature is displayed. All zones tied to that relay will also light.





example:  with relay 3 blinking indicates relay 3 will trip when any zone it monitors goes over 70°C.



 with the red alarm light on indicates the audible alarm will sound when any zone it monitors drops under 0°C.

### TEST FUNCTION

The test button is used to check input, output, and display operation. It is also used to restore operation of inputs which had faulty wiring that has now been corrected. See Troubleshooting on page 18.

Test Sequence:

1. When the test button is first pressed, all the display lamps will light and the alarm will sound for a couple seconds.
2. The inputs are automatically tested next. The display will read , , , or  for zone 1.

To view the status of other inputs/zones, press  or .

3. If programmed, pushing the test button again will trip specified output relays to test remote alarms or annunciators. Otherwise, it will return the CT124 to normal operation.

Pushing test again will return the CT124 to normal operation. If you forget to push test, the CT124 will automatically resume normal operation in about 60 seconds.

### SILENCE FUNCTION

If the alarm is sounding, push the SILENCE button to quiet the alarm. The alarm may sound again later if the alarm condition still exists after *Time of Silence* has expired (see the CT124 Setup Worksheet). Any new alarm conditions will override the silence function. Depending on your application, pushing SILENCE may also turn off selected output relays to quiet remote alarms or turn off annunciators.

### OVERRIDE FUNCTION

Depending upon your application, this button can be used to force any output relay(s) either on or off, including unused relays. Refer to the Setup Worksheet filled out for your application.







## PROGRAMMING INSTRUCTIONS

Before you begin programming the CT124, fill out a blank copy of the CT124 Setup Worksheet included with this manual. You will then have a detailed description of the program parameters of your CT124 for use as a reference in programming and operation.





### ENTERING AND LEAVING THE PROGRAM MODE

The CT124 requires a special sequence of keystrokes to enter the program mode. This prevents unauthorized changes to trip points and other functions.

#### To enter the program mode:

1. Press . You will see .
2. Press  and  at the same time. The CT124 will beep three times and display: .
3. Press  once to begin programming.

#### To exit the program mode:

1. Press  or  repeatedly until you see .
2. Press . The display will return to zone temperature.

### GENERAL PROGRAMMING INSTRUCTIONS



#### Program Display:

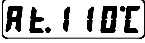

The CT124 display will show an operation code at the left and the selected parameter at the right. Zone, relay, and alarm lights indicate which input or output you are currently programming.

examples:  with the alarm light on, this programs the alarm to trip at 110°C.

 with zone 1 and relay 3 LED's lit, this programs relay 3 to respond to inputs from zone 1.

#### Changing Program Choices:

- Press  or  to cycle among the various choices at each programming step.

When the program requires a number input (e.g. a trip temperature), press the arrow buttons to raise and lower the displayed temperature. If you desire  as a choice, press  until  appears below -40°.





#### Storing Program Choices:

- Press  to store the current choice and advance to the next step. The order of steps follows the Setup Worksheet: Left to right, top to bottom.

## PROGRAMMING

### Backing Up:

- Press  to cancel your current choice and back up to the previous step. Press it repeatedly to move backward through all previous program steps.

Note: The  button only cancels the most recent program step. Any steps previous to that are already stored in the CT124's memory. Pressing  while programming relays or zones returns you a step at a time to the front of the line you are on. When at the beginning of a line,  will move you to the beginning of the previous line. The  button always moves you forward in single steps.

### PROGRAMMING STEPS

*The first letter of code below indicates: d = Display, r = Relay, A = Alarm*

#### Display:

<u>Code</u>	<u>Choices</u>	<u>Description</u>
dS	°C or °F	Display Scale: Set the temperature scale to degrees Celsius or degrees Fahrenheit. Trip points automatically convert to the new scale.
dC	HI LO AnY	Display Channel: If the keyboard has been untouched for 15 seconds, the CT124 will switch to display the highest or lowest temperature being sensed, or any (last) selected zone.

#### Relays and Alarms:

*Each step is repeated for each relay and the alarm.*

rt or At	-40 to 250°C -40 to 492°F (to 530°C or 986°F with platinum RTD) OFF	Relay or Alarm Trip Temperature: Set the trip point temperature for the indicated relay or alarm. Select "OFF" (below 40°) to lock out the output. Subsequent programming steps will skip a locked-out relay or alarm.
rH or AH	2 to 20°C 2 to 20°F	Relay or Alarm Hysteresis: Set the hysteresis (deadband) for the indicated relay or alarm.
rP or AP	HI or Lo	Relay or Alarm Trip mode: Set the relay or alarm to trip on overtemperature (HI) or undertemperature (Lo).
rA	YES or no	Relay Alarm: Sound alarm when the indicated relay trips?
rS	YES or no	Relay Silence: Untrip this relay (return to normal) when Silence is pressed?
AS	1 to 60 or - - -	Alarm Silence: Set the duration of alarm silence in minutes. Select "- - -" (above 60) if the silence is not to be timed. Any new alarms will cause the alarm to sound.
rd	YES or no	Relay Diagnostic Test: Should the indicated relay trip when the test button is pressed?
ro or Ao	no On OFF	Relay or Alarm Override: Select effect of override on alarm or relay. Select "no" for no effect.

## PROGRAMMING

### Input Zones:

*Each step is repeated for each temperature input zone.*

<u>Code</u>	<u>Choices</u>	<u>Description</u>
Sc	YES or no	Scan: Select if the indicated zone is to be scanned or locked out.
r or A	YES or no	Relay or Alarm: For each scanned zone, select whether the indicated relay or alarm will respond to that zone.

### Calibration:

CAL	YES or no	Press  , unless you want to recalibrate. Calibration instructions are on page 20.
-----	-----------	--

## SAMPLE WORKSHEET DESCRIPTIONS

On the following pages are three sample CT124 Setup Worksheets. These will demonstrate the types of functions the CT124 can perform and how to code them into the worksheet.

### **Worksheet 1:**

1. Monitor a transformer with three RTD's in the phase windings.
2. Relay 1 is connected to cooling fans and trips at 110°C.
3. Relay 2 is connected to an external alarm, and trips at 140°C. The built-in alarm also goes off.
4. Relay 3 shuts the transformer down at 155°C.
5. The override button manually turns on the fans.
6. The silence button turns off both the internal and external alarms.

### **Worksheet 2:**

1. Monitor a motor with three RTD's in the stator windings and two in the bearings.
2. If the stators reach 140°C, sound the alarm. Trip relay 2 to shut the motor down if they reach 155°C.
3. Sound the alarm if the bearings reach 100°C and trip relay 4 to shut the motor down if they reach 110°C.

### **Worksheet 3:**

1. Monitor seven pipes and room air temperature in a utility room.
2. Relay 1 acts as an on-off controller to run an auxiliary heater maintaining pipe temperature around 38°F.
3. Sound the alarm as a frost warning if any of the pipes drops below 35°F.



## CT124 SETUP WORKSHEET

Use this worksheet to describe the setup parameters for the desired operation of the CT124.

Fill in a short description of the location and purpose of each temperature sensor, and save the worksheet for future reference.

<b>Basic function description:</b> Transformer temperature monitor and cooling fan controller		
<b>Description of Zones</b>	<b>Description of Relay Functions</b>	<b>Trip Temp.</b>
<b>Zone 1:</b> Phase A winding	<b>Relay 1:</b> Fans	110°C
<b>Zone 2:</b> Phase B winding	<b>Relay 2:</b> External Alarm	140°C
<b>Zone 3:</b> Phase C winding	<b>Relay 3:</b> Shutdown	155°C
<b>Zone 4:</b> ---	<b>Relay 4:</b> ---	
<b>Zone 5:</b> ---		
<b>Zone 6:</b> ---	<b>Alarm only:</b> ---	
<b>Zone 7:</b> ---		
<b>Zone 8:</b> ---	<b>Completed by:</b> BFJ	<b>Date:</b> 9/87

Circle the option desired. If the box is empty, fill in a number within the range given at the left. If shaded, there is no option to choose.

**DISPLAY**

Code	Description	
dS	Temperature scale	°F °C
dC	Zone to be displayed during normal operation:	<input checked="" type="radio"/> HI <input type="radio"/> LO <input type="radio"/> AnY

**OUTPUTS - RELAYS AND ALARM**

	Relay 1	Relay 2	Relay 3	Relay 4	Alarm	
rt or At	Trip temperature: -40 to 482°F, -40 to 250°C (to 530°C or 986°F with Platinum RTD) or "OFF" if the output will not be used	110	140	155	OFF	OFF
rH or AH	Hysteresis (deadband): 2 to 20 °C or °F	2	2	2		
rP or AP	Trip on overtemperature (HI) or undertemperature (LO)	<input checked="" type="radio"/> HI <input type="radio"/> LO	<input checked="" type="radio"/> HI <input type="radio"/> LO	<input checked="" type="radio"/> HI <input type="radio"/> LO	HI LO	HI LO
rA	Sound audible alarm when this relay trips?	YES <input checked="" type="radio"/> no	YES <input checked="" type="radio"/> no	YES <input checked="" type="radio"/> no	YES no	
rS	Return this relay to normal when silence is pressed?	YES <input checked="" type="radio"/> no	YES <input checked="" type="radio"/> no	YES <input checked="" type="radio"/> no	YES no	
AS	Length of alarm silence: 1 to 60 minutes, "---" for stays off.					60
rd or Ad	Trip this output during diagnostic test?	YES <input checked="" type="radio"/> no	YES <input checked="" type="radio"/> no	YES <input checked="" type="radio"/> no	YES no	
ro or Ao	Effect of override button on output:	No effect <input type="radio"/> Trip <input checked="" type="radio"/> Untrip	<input type="radio"/> no <input checked="" type="radio"/> On <input type="radio"/> OFF	<input type="radio"/> no <input checked="" type="radio"/> On <input type="radio"/> OFF	<input type="radio"/> no <input checked="" type="radio"/> On <input type="radio"/> OFF	<input type="radio"/> no <input checked="" type="radio"/> On <input type="radio"/> OFF

**INPUT ZONES**

	Zone	Scan	Relay 1	Relay 2	Relay 3	Relay 4	Alarm
Sc. First Column: Zones to be scanned: YES = scanned no = locked out  Remaining columns: Outputs which respond to each zone: YES = Output will trip on zone temperature no = Output not tied to that zone	1	<input checked="" type="radio"/> YES <input type="radio"/> no	<input checked="" type="radio"/> YES <input type="radio"/> no	<input checked="" type="radio"/> YES <input type="radio"/> no	<input checked="" type="radio"/> YES <input type="radio"/> no	YES no	YES no
	2	<input checked="" type="radio"/> YES <input type="radio"/> no	<input checked="" type="radio"/> YES <input type="radio"/> no	<input checked="" type="radio"/> YES <input type="radio"/> no	<input checked="" type="radio"/> YES <input type="radio"/> no	YES no	YES no
	3	<input checked="" type="radio"/> YES <input type="radio"/> no	<input checked="" type="radio"/> YES <input type="radio"/> no	<input checked="" type="radio"/> YES <input type="radio"/> no	<input checked="" type="radio"/> YES <input type="radio"/> no	YES no	YES no
	4	YES <input checked="" type="radio"/> no	YES no	YES no	YES no	YES no	YES no
	5	YES <input checked="" type="radio"/> no	YES no	YES no	YES no	YES no	YES no
	6	YES <input checked="" type="radio"/> no	YES no	YES no	YES no	YES no	YES no
	7	YES <input checked="" type="radio"/> no	YES no	YES no	YES no	YES no	YES no
	8	YES <input checked="" type="radio"/> no	YES no	YES no	YES no	YES no	YES no

**CALIBRATION**

CAL.	Press DONE unless you wish to recalibrate. See p. 20 of the Instruction Manual.
------	---

## CT124 SETUP WORKSHEET

Use this worksheet to describe the setup parameters for the desired operation of the CT124.

Fill in a short description of the location and purpose of each temperature sensor, and save the worksheet for future reference.

<b>Basic function description:</b> Monitor motor windings & bearings		
Description of Zones	Description of Relay Functions	Trip Temp.
Zone 1: Stator #1	Relay 1: Stator overtemp alarm	140°C
Zone 2: Stator #2	Relay 2: Stator shutdown	155°C
Zone 3: Stator #3	Relay 3: Bearing overtemp alarm	100°C
Zone 4: Bearing #1	Relay 4: Bearing shutdown	110°C
Zone 5: Bearing #2		
Zone 6: ---	Alarm only: ---	
Zone 7: ---		
Zone 8: ---	Completed by: BFJ	Date: 9/87

Circle the option desired. If the box is empty, fill in a number within the range given at the left. If shaded, there is no option to choose.

### DISPLAY

Code	Description	°F °C
dS	Temperature scale	<input checked="" type="radio"/> °F <input type="radio"/> °C
dC	Zone to be displayed during normal operation: Highest zone Lowest zone Any selected zone	<input type="radio"/> HI <input type="radio"/> LO <input checked="" type="radio"/> Any

### OUTPUTS - RELAYS AND ALARM

		Relay 1	Relay 2	Relay 3	Relay 4	Alarm
rt or At	Trip temperature: -40 to 482°F, -40 to 250°C (to 530°C or 986°F with Platinum RTD) or "OFF" if the output will not be used	140	155	100	110	OFF
rH or AH	Hysteresis (deadband): 2 to 20 °C or °F	2	2	2	2	
rP or AP	Trip on overtemperature (HI) or undertemperature (LO)	<input checked="" type="radio"/> HI <input type="radio"/> LO	<input checked="" type="radio"/> HI <input type="radio"/> LO	<input checked="" type="radio"/> HI <input type="radio"/> LO	<input checked="" type="radio"/> HI <input type="radio"/> LO	HI LO
rA	Sound audible alarm when this relay trips?	<input checked="" type="radio"/> YES <input type="radio"/> no	<input checked="" type="radio"/> YES <input type="radio"/> no	<input checked="" type="radio"/> YES <input type="radio"/> no	<input checked="" type="radio"/> YES <input type="radio"/> no	
rS	Return this relay to normal when silence is pressed?	<input checked="" type="radio"/> YES <input type="radio"/> no	<input checked="" type="radio"/> YES <input type="radio"/> no	<input checked="" type="radio"/> YES <input type="radio"/> no	<input checked="" type="radio"/> YES <input type="radio"/> no	
AS	Length of alarm silence: 1 to 60 minutes, "---" for stays off.					10
rd or Ad	Trip this output during diagnostic test?	<input checked="" type="radio"/> YES <input type="radio"/> no	<input checked="" type="radio"/> YES <input type="radio"/> no	<input checked="" type="radio"/> YES <input type="radio"/> no	<input checked="" type="radio"/> YES <input type="radio"/> no	
ro or Ao	Effect of override button on output: No effect Trip Untrip	no <input type="radio"/> On <input checked="" type="radio"/> OFF	no <input type="radio"/> On <input checked="" type="radio"/> OFF	no <input type="radio"/> On <input checked="" type="radio"/> OFF	no <input type="radio"/> On <input checked="" type="radio"/> OFF	no <input type="radio"/> On <input checked="" type="radio"/> OFF

### INPUT ZONES

		Zone	Scan	Relay 1	Relay 2	Relay 3	Relay 4	Alarm	
Sc.  r. or A.	<u>First Column:</u> Zones to be scanned: YES = scanned no = locked out	1	<input checked="" type="radio"/> YES <input type="radio"/> no	<input checked="" type="radio"/> YES <input type="radio"/> no	<input checked="" type="radio"/> YES <input type="radio"/> no	<input checked="" type="radio"/> YES <input type="radio"/> no	<input checked="" type="radio"/> YES <input type="radio"/> no	YES no	
		2	<input checked="" type="radio"/> YES <input type="radio"/> no	<input checked="" type="radio"/> YES <input type="radio"/> no	<input checked="" type="radio"/> YES <input type="radio"/> no	<input checked="" type="radio"/> YES <input type="radio"/> no	<input checked="" type="radio"/> YES <input type="radio"/> no	YES no	
		3	<input checked="" type="radio"/> YES <input type="radio"/> no	<input checked="" type="radio"/> YES <input type="radio"/> no	<input checked="" type="radio"/> YES <input type="radio"/> no	<input checked="" type="radio"/> YES <input type="radio"/> no	<input checked="" type="radio"/> YES <input type="radio"/> no	YES no	
		4	<input checked="" type="radio"/> YES <input type="radio"/> no	<input checked="" type="radio"/> YES <input type="radio"/> no	<input checked="" type="radio"/> YES <input type="radio"/> no	<input checked="" type="radio"/> YES <input type="radio"/> no	<input checked="" type="radio"/> YES <input type="radio"/> no	YES no	
	<u>Remaining columns:</u> Outputs which respond to each zone: YES = Output will trip on zone temperature no = Output not tied to that zone	5	<input checked="" type="radio"/> YES <input type="radio"/> no	<input checked="" type="radio"/> YES <input type="radio"/> no	<input checked="" type="radio"/> YES <input type="radio"/> no	<input checked="" type="radio"/> YES <input type="radio"/> no	<input checked="" type="radio"/> YES <input type="radio"/> no	<input checked="" type="radio"/> YES <input type="radio"/> no	YES no
		6	<input checked="" type="radio"/> YES <input type="radio"/> no	YES no	YES no	YES no	YES no	YES no	YES no
		7	<input checked="" type="radio"/> YES <input type="radio"/> no	YES no	YES no	YES no	YES no	YES no	YES no
		8	<input checked="" type="radio"/> YES <input type="radio"/> no	YES no	YES no	YES no	YES no	YES no	YES no

### CALIBRATION

CAL.	Press DONE unless you wish to recalibrate. See p. 20 of the Instruction Manual.
------	---

## CT124 SETUP WORKSHEET

Use this worksheet to describe the setup parameters for the desired operation of the CT124.

Fill in a short description of the location and purpose of each temperature sensor, and save the worksheet for future reference.

<b>Basic function description:</b>		
Monitor pipe temps, control auxiliary heater, frost alarm		
Description of Zones	Description of Relay Functions	Trip Temp.
Zone 1: Pipe #1	Relay 1: Auxiliary heat control	38°F
Zone 2: Pipe #2	Relay 2: ---	
Zone 3: Pipe #3	Relay 3: ---	
Zone 4: Pipe #4	Relay 4: ---	
Zone 5: Pipe #5		
Zone 6: Pipe #6	Alarm only: Frost warning	35°F
Zone 7: Pipe #7		
Zone 8: Room temp (monitor only)	Completed by: BFJ	Date: 9/87

Circle the option desired. If the box is empty, fill in a number within the range given at the left. If shaded, there is no option to choose.

**DISPLAY**

Code	Description	
dS	Temperature scale	<input checked="" type="radio"/> °F, <input type="radio"/> °C
dC	Zone to be displayed during normal operation:	Highest zone <input type="radio"/> HI Lowest zone <input checked="" type="radio"/> LO Any selected zone <input type="radio"/> AnY

OUTPUTS - RELAYS AND ALARM		Relay 1	Relay 2	Relay 3	Relay 4	Alarm
rt or At	Trip temperature: -40 to 482°F, -40 to 250°C (to 530°C or 986°F with Platinum RTD) or "OFF" if the output will not be used	38	OFF	OFF	OFF	35
rH or AH	Hysteresis (deadband): 2 to 20 °C or °F	4				2
rP or AP	Trip on overtemperature (HI) or undertemperature (LO)	<input checked="" type="radio"/> HI <input checked="" type="radio"/> LO	HI LO	HI LO	HI LO	<input checked="" type="radio"/> HI <input checked="" type="radio"/> LO
rA	Sound audible alarm when this relay trips?	YES <input checked="" type="radio"/> no	YES no	YES no	YES no	
rS	Return this relay to normal when silence is pressed?	YES <input checked="" type="radio"/> no	YES no	YES no	YES no	
AS	Length of alarm silence: 1 to 60 minutes, "---" for stays off.					30
rd or Ad	Trip this output during diagnostic test?	<input checked="" type="radio"/> YES <input type="radio"/> no	YES no	YES no	YES no	
ro or Ao	Effect of override button on output:	No effect <input type="radio"/> no Trip <input checked="" type="radio"/> On Untrip <input type="radio"/> OFF	<input checked="" type="radio"/> no On OFF	<input checked="" type="radio"/> no On OFF	<input checked="" type="radio"/> no On OFF	<input checked="" type="radio"/> no On OFF

INPUT ZONES		Zone	Scan	Relay 1	Relay 2	Relay 3	Relay 4	Alarm
Sc.       r. or A.	<u>First Column:</u> Zones to be scanned: YES = scanned no = locked out	1	<input checked="" type="radio"/> YES <input type="radio"/> no	<input checked="" type="radio"/> YES <input type="radio"/> no	YES no	YES no	YES no	<input checked="" type="radio"/> YES <input type="radio"/> no
		2	<input checked="" type="radio"/> YES <input type="radio"/> no	<input checked="" type="radio"/> YES <input type="radio"/> no	YES no	YES no	YES no	<input checked="" type="radio"/> YES <input type="radio"/> no
		3	<input checked="" type="radio"/> YES <input type="radio"/> no	<input checked="" type="radio"/> YES <input type="radio"/> no	YES no	YES no	YES no	<input checked="" type="radio"/> YES <input type="radio"/> no
		4	<input checked="" type="radio"/> YES <input type="radio"/> no	<input checked="" type="radio"/> YES <input type="radio"/> no	YES no	YES no	YES no	<input checked="" type="radio"/> YES <input type="radio"/> no
		5	<input checked="" type="radio"/> YES <input type="radio"/> no	<input checked="" type="radio"/> YES <input type="radio"/> no	YES no	YES no	YES no	<input checked="" type="radio"/> YES <input type="radio"/> no
		6	<input checked="" type="radio"/> YES <input type="radio"/> no	<input checked="" type="radio"/> YES <input type="radio"/> no	YES no	YES no	YES no	<input checked="" type="radio"/> YES <input type="radio"/> no
		7	<input checked="" type="radio"/> YES <input type="radio"/> no	<input checked="" type="radio"/> YES <input type="radio"/> no	YES no	YES no	YES no	<input checked="" type="radio"/> YES <input type="radio"/> no
		8	<input checked="" type="radio"/> YES <input type="radio"/> no	<input checked="" type="radio"/> YES <input type="radio"/> no	YES no	YES no	YES no	<input checked="" type="radio"/> YES <input type="radio"/> no
<u>Remaining columns:</u> Outputs which respond to each zone: YES = Output will trip on zone temperature no = Output not tied to that zone								

**CALIBRATION**

CAL.	Press DONE unless you wish to recalibrate. See p. 20 of the Instruction Manual.
------	---

## TROUBLESHOOTING INSTRUCTIONS

### ERROR MESSAGES

The alarm will sound at the same time these messages are displayed. Push silence to quiet the alarm and acknowledge the problem. These messages indicate that some or all of the protection of your associated equipment has been interrupted.

- Open**: OPEN: There is a break in the indicated input RTD wiring or the resistance represents a temperature higher than the temperature range of the CT124.
- Short**: SHORT: There is a short in the indicated input RTD wiring or the resistance represents a temperature lower than the temperature range of the CT124.
- FAULT**: FAULT: The RTD for the indicated input zone has an intermittent problem. This message will also appear after a "short" or "open" has been fixed. To restore operation of that zone, perform the test sequence described on page 11.
- Error 1**: ERROR 1: This indicates that the CT124's non-volatile memory has been corrupted. The message may flash slowly while sounding the alarm (see below).

### Recovering From Error 1

If the memory test fails when the CT124 is powered up, Error1 is displayed. This is designed to occur when the useful life of the non-volatile memory has expired (typically greater than 10 years). Extreme power line transients may also corrupt the memory. You may or may not be able to restore operation. Perform the following steps to attempt recovery:

1. Disconnect or shutdown any equipment connected to the output relays. The following steps may have an unpredictable effect on the outputs.
2. Enter programming mode (see page 12). The display should read **prog**.
3. Push **CLR PEAK** twice. The display should read **prog** again.
4. Push **PROGRAM**. If the display begins to read normal temperatures, go to step 6.
5. If the display reads **F. CAL**, push **PROGRAM**.

If the display begins to read normal temperatures, go to step 6.

If it still reads **F. CAL**, your CT124 has permanently lost the factory calibration data stored inside. You may be able to recalibrate using the calibration instructions (see page 20), but you will not be able to restore factory calibration in the future unless the unit is returned to the factory (see page 21).

6. Double check the CT124's program against the setup worksheet for your application. Follow the programming instructions on page 12.
7. Cycle the CT124's power OFF and ON once to see that normal operation is restored.

### INCORRECT TEMPERATURE READINGS

Most incorrect temperature readings are due to errors involving the RTD's and their connections to the CT124. The following list contains suggestions to ensure the CT124 is reading the temperature correctly.

1. Make sure that the proper RTD element is attached. For example, a CT124PD requires a PD-type RTD for accurate measurement. Refer to the model number decoding information on page 23 for RTD type compatibility.
2. Use 3-lead RTD's. Refer to the installation instructions concerning the connection of 2- and 3-lead RTD's.
3. Check for proper 3-lead compensation; the resistance of the leads going to the RTD must be well matched. For example, a difference of 1 ohm can mean more than 2.5°C (4.6°F) error for a platinum RTD, or more than 26°C (47°F) error for a copper RTD. A good way to do this is to measure the resistance between each leadwire while shorting the wires together at or near the RTD. All 3 readings should match each other.
4. Recalibration may be necessary (see page 20).

### TEMPERATURE INSTABILITY

The CT124 display should show a stable reading and occasionally flip  $\pm 1$  count under stable input conditions. If your display changes by more than one digit, excessive electrical noise is being introduced to the CT124, and fouling the measurements. There are a number of actions that may improve noise immunity. A few things to try are:

1. Use twisted and/or shielded leads for the RTD's. If shielded wire is used, make sure the shield is insulated from ground along its full length and makes only one connection at the CT124's terminal block.
2. Make sure the RTD wires are routed away from noisy sources. Refer to the RTD wiring instructions on page 7.
3. Look for other equipment operating off the same branch circuit that may emit electrical noise. Nearby motors, contactors, or computer equipment may emit electrical noise through the power line that overpowers the noise filtering circuits inside the CT124. Look for an alternative branch circuit for the CT124 or place a line filter between the power source and the CT124.
4. Disconnect the earth ground at the power terminals on the rear connector board of the CT124. Because the CT124 case is made of a plastic, this ground is not required for safety reasons. Removing it may eliminate some capacitively coupled noise.

### NO DISPLAY







1. Make sure that the internal power supply switch is set for the appropriate voltage. See Figure 3.
2. Read the safety precautions on page 2 and check internal and external fuses or breakers (see page 5). Replace blown fuses with identical ones.

If the previous suggestions did not reveal the source of the problem, please contact MINCO for help. Information about our return/loaner/exchange program is on page 21.



## CALIBRATION INSTRUCTIONS

The CT124 is factory calibrated and only requires recalibration if the RTD board is replaced, the non-volatile RAM fails, or long-term high accuracy is required. Annual calibration is recommended to maintain the CT124's specified accuracy for many years.

Calibration is very simple if you use a Minco AC758 RTD Simulator. Alternatively, you may use 9 individual precision resistors, of which 8 are used to simultaneously simulate each input RTD at 0°C (32°F) and the other is used to simulate 195°C (383°F).

1. Enter the programming mode and step through the program until the display reads **CAL. no** (see page 12).
2. Press  and  together to change the display to **CALYES**. Press  twice to exit the program mode. The display should now read **F. CAL** (Factory Calibration).
3. If you do **not** have an AC758 RTD simulator, leave the calibration mode now by pressing . Otherwise, press  or  so the display reads **U. CAL** (User Calibration).
4. Press . The display should now read **C. 0 C**.
5. Unplug the RTD connector board from the rear of the CT124 and replace it with the AC758. Be sure the 2-letter code of the RTD type is correct; e.g. use an AC758PD RTD Simulator with a CT124PD Controller (see model number coding on page 23).

If you do not have an AC758, connect 8 resistors of the proper value to simulate 0°C into the terminal blocks. Make sure you provide a 3-lead connection.

6. Set the Switch on the AC758 to 0°C and press . The CT124 will calibrate itself to 0°C and then display **C. 195 C**.
7. Set the switch on the AC758 to 195°C (or install a resistor into the zone 1 RTD position that simulates the RTD at 195°C) and press . The CT124 will calibrate itself to 195°C and then display **Cont** (Continue).
8. Remove the AC758 and reinstall the RTD connector board.
9. Press . Calibration is complete when the display returns to zone temperature. If the display goes back to reading **F. CAL**, something went wrong during calibration. Try again, starting at step 3.

## TROUBLESHOOTING

### **RETURN FOR REPAIR**

Our Warranty policy is printed on back page of this manual. Please help us by calling Minco or include a note describing the problem with as much detail as possible.

### **CT124 LOANER/EXCHANGE PROGRAM**

It is our policy to handle returns in a timely manner, but some applications may require immediate action. If your CT124 should fail and it must be replaced within hours rather than a few days or weeks, we have developed a convenient loaner/exchange program. Call Minco for details.

### **SPARE PARTS LIST**

Minco has not prepared a spare parts list. In some cases we can diagnose problems over the phone and determine if replacement parts can be installed by the user. In most cases, however, simple user repair is not possible.

**SPECIFICATIONS**

Input:	1 to 8 RTD's (Resistance Temperature Detectors), 2 or 3-wire. See part number coding on page 23 for details.
Input scan rate:	8 readings per second.
Input fault detection:	Open or shorted circuit sounds alarm and locks out faulty zone. Other zones are unaffected.
Input protection:	±30 VDC continuous from any input to ground.
Output:	5 independent trip points: 4 relays and one audible alarm. Alarm may be programmed to sound when selected relays trip.
Relays:	Form C, SPDT 10 Amps @ 250 VAC/24 VDC Resistive 20 Amps make current 2500 VA breaking capacity 1/4 HP at 120 VAC motor load
Trip point hysteresis (deadband):	Programmable from 2 to 20° (C or F).
Display:	0.56" (14mm) LED, 1°C or 1°F resolution. 16 LED indicators.
Accuracy:	±2°C (±3°F) in 10 to 30°C (50 to 86°F) ambients. ±3°C (±5°F) in 0 to 70°C (32 to 158°F) ambients.
Zone and relay labels:	Replaceable from inside for custom labeling.
Supply power:	AC Version: 115 or 230 VAC ±10%, 50/60 Hz. 15 Watts maximum. Selector switch inside case. DC Version: 24 VDC ±10%. 15 Watts maximum.
Power loss protection:	Trip points, peaks, and program parameters stored in non-volatile memory. Normal operation resumes when power is restored.
Keyboard:	10 membrane type keys with audible feedback.
Programming:	Programmable from front panel. Access to program mode requires special key sequence. See sample setup worksheet for complete list of program options.
Firmware fault protection:	Watchdog circuit resets microprocessor if it fails to perform program sequence.
Enclosure:	ABS case; water and dust resistant front panel.
Ambient temperature rating:	0 to 70°C (32 to 158°F).
Connections:	Plug-in terminal boards at rear accept wires to 14 AWG.
Leadwire Resistance Compensation:	Up to 10 Ω per leadwire with no effect on reading. Contact the factory if planning to use a safety barrier for use in hazardous locations.
Mounting:	3/4 DIN (DIN43700). Panel-mounted in 5.51" x 7.32" (140mm x 186mm). Extends behind panel 5.1" (130mm) maximum.
Weight:	4 lbs. (1.8 kg.).



### MODEL NUMBER CODING

CT124

PA

1

Sample part number: CT124PA1

Power Supply:

- 1 = 115/230 VAC
- 2 = 24 VDC

RTD type and range:

- PA = 100  $\Omega$  Platinum, TCR = 0.00392, -40 to 530°C (986°F)
- PB = 100  $\Omega$  Platinum, TCR = 0.00391, -40 to 530°C (986°F)
- PD = 100  $\Omega$  Platinum, TCR = 0.00385, -40 to 530°C (986°F)
- (PE = same as PD, but sensor has wider tolerances)
- PF = 1000  $\Omega$  Platinum, TCR = 0.00385, -40 to 530°C (986°F)
- NA = 120  $\Omega$  Nickel, TCR = 0.00672, -40 to 250°C (482°F)
- CA = 10  $\Omega$  Copper, TCR = 0.00427, -40 to 250°C (482°F)

Base model number:

CT124

## **WARRANTY**

Items returned within one year from the date of sale, transportation prepaid, which Minco Products, Inc. (The "Seller") reasonably determines to be faulty by reason of defective materials or faulty workmanship will be replaced or repaired at the Seller's discretion, free of charge.

This remedy is to be the sole and exclusive remedy available to the buyer in the event of a breach by the Seller. Items that show evidence of mishandling or misapplication may be returned by the Seller at the customer's expense.

Furthermore, the Seller is not to be held responsible for consequential damages caused by its product except as required under Minnesota Statutes, Section 336.1-719 (3).

This warranty is expressly in lieu of any other expressed warranty or implied warranty of merchantability or fitness for a particular purpose, and of any other obligations or liability on the part of the Seller or its employees and agents.