

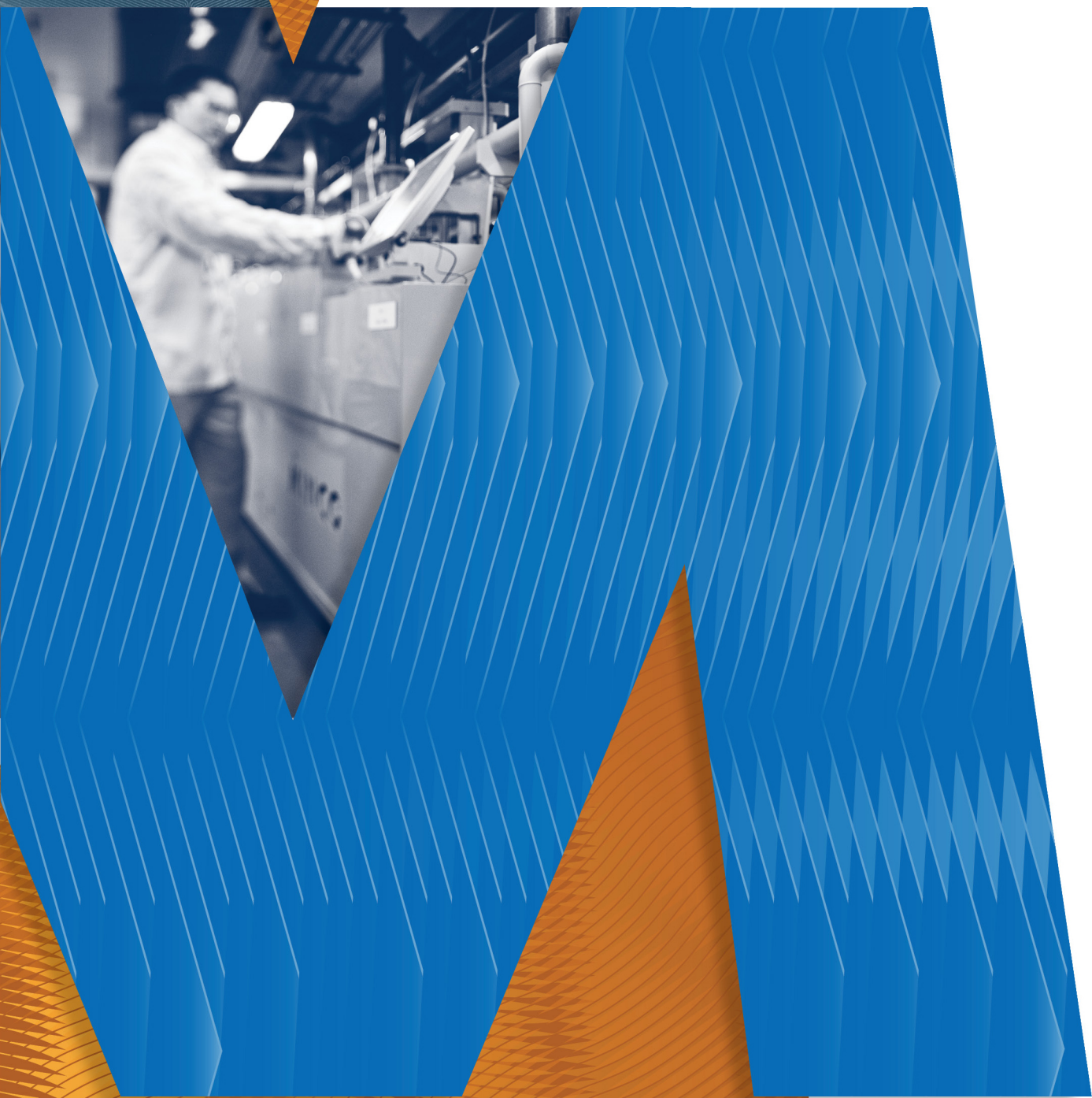

HVAC Sensors Design Guide



HVAC Sensors Design Guide

Build the perfect HVAC solution today

This design guide is comprised of products that are designed for, or are often used in, the HVAC industry. Refer to other Minco publications for temperature sensors designed for industries such as rotating equipment, power generation, oil & gas, medical diagnostics, aerospace, defense, semicon, telecom, food & dairy, etc. The guide will assist the reader in identifying appropriate standard temperature sensors that are available. Minco also supplies many custom temperature sensors designed for unique and specialized applications; contact a member of the Minco sales team for assistance with these standard products or a customized design.

HVAC (or HVAC/R or Building Management) systems utilize a wide variety of temperature sensors and humidity sensors to effectively control air temperature and comfort in virtually all commercial and residential settings.

Minco temperature sensors and humidity sensors are specifically designed to provide accurate and repeatable measurements in the varied applications within HVAC environments. These include wall mount, outside air, immersion (for heat exchange fluids), duct point, duct averaging, surface mount thermal ribbon and probe type temperature sensors. The temperature sensors can be ordered with the common RTD element types and temperature coefficients of resistance (TCR) including, but not limited to, 100 ohm .00375 platinum, 100 ohm .00385 platinum, 100 ohm, .00391 platinum, 1000 ohm .00385 platinum, 1000 ohm .00527 nickel-iron (Balco) and 2000 ohm .00527 nickel iron. Moreover, 4-20mA transmitters (Minco Temptrans) can be added to any of RTDs to economically convert the resistance output of the RTD to a current output which is ideal in noisy (high EMI) environments or when the sensors are located long distances from the control system.

Getting Started

| | |
|---|----|
| The Minco Difference | 3 |
| How to Choose a Sensor | 4 |
| Designing for Accuracy | 5 |
| RTD, Thermocouple, or Thermistor | 6 |
| Choosing Sensor Elements | 7 |
| RTD Connections -- 2-wire, 3-wire, 4-wire | 8 |
| Resistance/Temperature Tables | 9 |
| Thermocouple Voltage/Temperature Tables | 10 |
| Temperature Coefficient of Resistance (TCR) | 11 |
| Frequently Asked Questions | 12 |

Temperature Sensors

| | |
|--|----|
| Averaging Temperature Sensors | 16 |
| Chill-Out™ Combination Sensors | 17 |
| Duct & Outside Air Temperature Sensors | 19 |
| Elements & Probes | 20 |
| Refrigeration & Freezer Temperature System | 21 |
| Room Air Temperature Sensors | 22 |
| Thermal Vial Temperature Sensing System | 23 |
| Thermal Ribbon and Thermal Tab Sensors | 25 |
| Bolt-On Sensors | 29 |
| Economy Sensors | 30 |
| Fluid Immersion Temperature Sensors | 31 |
| Fast-Response RTDs | 32 |

| | |
|-------------------------------------|----|
| Fast-Response Immersion RTDs | 33 |
| Compact Plug Sensor | 34 |
| Integrated Sensor-Transmitter | 35 |

Instruments

| | |
|---|----|
| Miniature DC Temperature Controller | 37 |
| Loop-Powered Indicator | 39 |
| Temptran 4 to 20 mA RTD Transmitter | 40 |
| Temptran Temperature Ranges | 42 |
| Programmable Temperature Transmitters | 44 |

Humidity Sensors

| | |
|--|----|
| Humidity Sensor/Transmitter Assembly | 47 |
| Hazardous Area Humidity Assembly | 49 |
| Intrinsically Safe Humidity Assembly | 51 |

Conductivity Level Sensor

| | |
|---------------------------------|----|
| Conductivity Level Sensor | 54 |
|---------------------------------|----|

Accessories

| | |
|------------------------------------|----|
| Fluid Immersion Fittings | 57 |
| Economy and HVAC Thermowells | 58 |
| Connection Heads | 59 |
| Extension Wire | 60 |



Getting Started

| | |
|---|----|
| The Minco Difference | 3 |
| How to Choose a Sensor | 4 |
| Designing for Accuracy | 5 |
| RTD, Thermocouple, or Thermistor | 6 |
| Choosing Sensor Elements | 7 |
| RTD Connections -- 2-wire, 3-wire, 4-wire | 8 |
| Resistance/Temperature Tables | 9 |
| Thermocouple Voltage/Temperature Tables | 10 |
| Temperature Coefficient of Resistance (TCR) | 11 |
| Frequently Asked Questions..... | 12 |

The Minco Difference

Harness Minco's knowledge and diverse product lines to create the perfect solution

Custom and integrated components

Minco operates four different product lines, all coordinated in the same facility for faster, seamless integration that can boost your time-to-market. This makes us unique in our ability to customize and integrate components into turnkey assemblies and complete thermal, sensing and flex circuitry solutions. All of our components can be designed, manufactured, and integrated to perfectly fit your application while providing matched system accuracy.

Disciplined NPI Process

Minco has developed a disciplined approach for up-front engineering engagement. Our early involvement in your design cycle enables us to take steps to identify and reduce risk, minimize cost, and increase reliability.

- Minco's NPI approach reduces the number of iterations
- Initial upfront design and manufacturability analysis performed at quote stage (DRC/DFM)
- Comprehensive, proactive design and process risk analysis to ensure robustness (DFMEA/PFMEA) and minimize delays

Custom solutions

Minco's customized products provide an affordable solution to meet your exact specifications. We work diligently to build our products with the greatest efficiency, quality, and accuracy to meet your critical standards and ensure ROI.

Minco can customize all of our products to perfectly fit your application.

Thermofoil Heaters

- Irregular shapes, size and holes for a precise fit
- Single or dual element for critical redundancy and rapid heat transfer
- Profiled and multi-zone heaters to put the heat exactly where you need it
- Leadwire, flex circuit or solder pad terminations for easy integration into your assembly

Sensors and instruments

- RTD and thermistor elements to match any TCR (temperature coefficient of resistance) curve
- Thermocouples in all popular types
- A variety of materials and machining options available to provide critical thermal response in your application
- Leadwire and cable options to meet your application parameters
- Custom transmitters, controllers, and monitors for accurate sensing packages

E2E — Engineer to Engineer

Minco seeks to help our customers by connecting our engineers with theirs. We call this collaboration E2E.

Early engineering involvement:

Quality, robust designs are best achieved when the engineering collaboration begins early in the design cycle. Engineering consultation can be invaluable early in the design process. Minco wants to make your access to engineering tools and expertise as convenient as possible.

Minco engineer review: Our engineers will review your quote or order documentation and data to determine if changes are needed for manufacturability. If needed, we will discuss these issues with you to our mutual agreement before construction begins.

Design services: Concept to finish or problem specific, design engineers are available to assist our customers. Contact Minco to begin working with the design engineer most able to help you with your specific design needs.

Contact Minco today to learn how our engineers can help with your next project.



Flex Circuits

- Single-layer, double-layer, multilayer and rigid-flex circuits with high layer counts to meet your interconnection needs
- Fine lines, circuit forming and selective bonding add to space and weight savings
- Stiffeners, pins, connectors and full turnkey electronics packaging for efficient integration into your application
- Inductive communication coils can be integrated with flex circuits to provide critical communication assemblies

Integrated solutions

All of Minco's products – Thermofoil Heaters, Flex Circuits, Sensors, Instruments – can be integrated into a single solution for greater efficiency. Whether it is a complete thermal optimization system or interconnection application, Minco's design engineers will partner with you to ensure success.

With integrated solutions there is less work on your end, and less that can go wrong. Our integrated assemblies truly lower your total cost of assembly because of less front end assembly, easy installation, and unparalleled quality and reliability.



How to Choose a Sensor

What kind of sensor do I need for my equipment?

Getting Started

Minco suggests following these steps when selecting a sensor:

1. Understand and define your application requirements

Many factors should be a part of the sensor system design process. The factors listed below can help you define the sensing requirements for your application. Define the typical and extremes of these environmental conditions:

- minimum and maximum temperatures
- pressure
- humidity
- shock
- vibration
- flow rate

Also ask:

- What is the sensed medium (a surface or immersed in solid, liquid or gas)?
- Is the medium chemically reactive (corrosive) or hazardous (explosive)?
- Is there high electromagnetic interference potential from power switching, rectification, or radio waves?

Finally, define the significance of these performance specifications in your application?

- sensing accuracy at a calibration point and/or over a temperature span
- repeatability
- stability
- sensor time constant
- insulation resistance

2. Determine which sensing technology options meet your requirements

Several potential sensing technologies may meet the essential environmental and performance specifications of your application.



3. Compare sensor construction alternatives for best fit and ease of use

While a sensing technology may appear to be capable of meeting the requirements of your application, the actual sensor packaging and construction must be evaluated in order to select the optimal cost/performance balance from the available technology options. Regardless of which sensing technology you consider, the packaging of the sensor introduces some level of specification compromise in terms of cost, performance or durability. Use this guide to compare Minco's various sensor constructions and instrumentation solutions to find the best fit for your application.

4. Obtain parts for testing as prototypes in your application

Minco has a wide selection of standard sensor components that can often be used for prototype testing and production systems. We would appreciate the opportunity to discuss your application with you. We can help ensure that the right sensor construction is selected for your application as well as any accessory components. Often times, we are able to offer recommendations for customization to improve performance and/or lower installed cost. Order sensors and instruments easily online at minco.com or contact your Minco sales representative.

Designing for Accuracy

Maximize accuracy with these solutions

Overview

How accurate is a temperature sensor? To many, the answer to this question is the sensor's interchangeability specification. For example, 100 Ω platinum RTDs are typically interchangeable within 0.1 Ω (0.3°C) at 0°C.

But interchangeability only tells how closely the electrical characteristics of a sensor conform to its published tables. What you really want to know is how much the temperature seen at your readout or controller deviates from the actual temperature of the material you are sensing. Interchangeability is only one of the potential sources of error in the system, and it is usually not the largest. Following are some other error modes along with suggested solutions.

Repeatability/stability

Challenge: Repeatability tells how well the sensor repeats subsequent readings at the same temperature. Stability is the absence of long term drift. In many cases, the user is less concerned with absolute accuracy than with the ability of a sensor to maintain a process at the same point once properly set.

Solution: Platinum RTDs are the most stable sensor in common use and are used to interpolate over the standard temperature scale from -260 to 962°C. Ordinary industrial models will drift less than 0.1°C per year in normal use.

Time lag

Challenge: When temperatures change rapidly, sensors may not keep up.

Solution: Minco specializes in fast response RTDs. Most models in this guide have a time constant of 2 seconds or less. Certain custom-designed models are faster yet.

Time constant is defined as the time it takes a sensor to reflect 63% of a step temperature change:

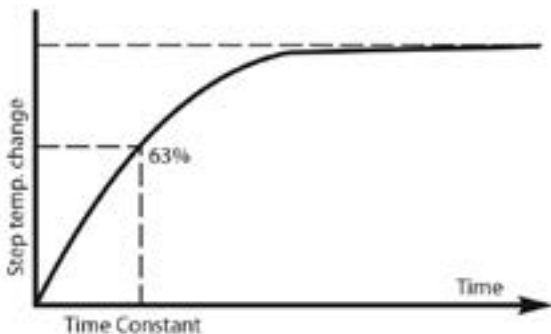

Conduction errors

Challenge: Heat conducted into sensors from ambient air alters the temperature of the sensing tip.

Solution: Use smaller sensors or tip-sensitive probes, and be sure they are sufficiently immersed or embedded in the sensed medium.

Point sensing errors

Challenge: In places where temperatures are stratified or gradients are large, the temperature at a single point may be unrepresentative or misleading.

Solution: Use temperature averaging probes or Thermal-Ribbons.

Leadwire resistance

Challenge: Resistance in the leads between RTDs and control points elevates apparent readings.

Solutions:

- Specify sensors with higher resistances.
- Use 3 or 4-wire compensating circuits—see page 8.
- Eliminate leadwire effects with a 4 to 20 mA transmitter. See page 37 for a variety of instrumentation.

Self-heating

Challenge: The measuring current through an RTD can raise its temperature above the true value.

Solution: As a general rule, limit current to 5 mA for industrial applications. Most Minco RTDs, and especially Thermal-Ribbons, have a large surface area to dissipate heat and reduce self-heating effects.

Custom designs

If you have special requirements -- or an OEM design -- Minco can typically manufacture a custom sensor solution to improve accuracy and reduce cost at the same time.

Contact Minco today to discuss your application.

RTD, Thermocouple, or Thermistor

Choose the right type of sensor for your application

RTDs

An RTD (resistance temperature detector) sensing element consists of a wire coil or deposited film of pure metal. The element's resistance increases with temperature in a known and repeatable manner. RTDs exhibit excellent accuracy over a wide temperature range and represent the fastest growing segment among industrial temperature sensors. Their advantages include:

- **Temperature range:** Minco models cover temperatures from -260 to 650°C (-436 to 1202°F).
- **Repeatability and stability:** The platinum resistance thermometer is the primary interpolation instrument used by the National Institute of Standards and Technology from -260 to 962°C. Ordinary industrial RTDs typically drift less than 0.1°C/year.
- **Sensitivity:** The voltage drop across an RTD provides a much larger output than a thermocouple.
- **Linearity:** Platinum and copper RTDs produce a more linear response than thermocouples or thermistors. RTD non-linearities can be corrected through proper design of resistive bridge networks.
- **Low system cost:** RTDs use ordinary copper extension leads and require no cold junction compensation.
- **Standardization:** Manufacturers offer RTDs to industry standard curves, most commonly 100 Ω platinum to EN60751 (Minco element code PD or PM).

Thermocouples

A thermocouple consists of two wires of dissimilar metals welded together into a junction. At the other end of the signal wires, usually as part of the input instrument, is another junction called the reference junction, which is electronically compensated for its ambient temperature.

Heating the sensing junction generates a thermoelectric potential (emf) proportional to the temperature difference between the two junctions. This millivolt-level emf, when compensated for the known temperature of the reference junction, indicates the temperature at the sensing tip. Thermocouples are simple and familiar. Designing them into systems, however, is complicated by the need for special extension wires and reference junction compensation. Thermocouple advantages include:

- **Extremely high temperature capability:** Thermocouples with precious metal junctions may be rated as high as 1800°C (3272°F).
- **Ruggedness:** The inherent simplicity of thermocouples makes them resistant to shock and vibration.
- **Small size/fast response:** A fine-wire thermocouple junction takes up little space and has low mass, making it suitable for point sensing and fast response. Note, however, that many Minco RTDs have time constants faster than equivalent thermocouples.

Thermistors

A thermistor is a resistive device composed of metal oxides formed into a bead and encapsulated in epoxy or glass. A typical thermistor shows a large negative temperature coefficient. Resistance drops dramatically and non-linearly with temperature. Sensitivity is many times that of RTDs but useful temperature range is limited. Some manufacturers offer thermistors with positive coefficients. Linearized models are also available.

There are wide variations of performance and price between thermistors from different sources. Typical benefits are:

- **Low sensor cost:** Basic thermistors are quite inexpensive. However, models with tighter interchangeability or extended temperature ranges often cost more than RTDs.
- **High sensitivity:** A thermistor may change resistance by tens of ohms per degree temperature change, versus a fraction of an ohm for RTDs.
- **Point sensing:** A thermistor bead can be made the size of a pin head for small area sensing.

| | RTD | Thermocouple | Thermistor |
|---------------------|--|---------------------------------|---|
| Temp range | -260 to 850°C (-436 to 1562°F) | -270 to 1800°C (-454 to 3272°F) | -80 to 150°C (-112 to 302°F) (typical) |
| Sensor cost | Moderate | Low | Low |
| System cost | Moderate | High | Moderate |
| Stability | Best | Low | Moderate |
| Sensitivity | Moderate | Low | Best |
| Linearity | Best | Moderate | Poor |
| Specify for: | General purpose sensing Highest accuracy Temperature averaging | Highest temperatures | Best sensitivity Narrow ranges (e.g. medical) Point sensing |

Choosing Sensor Elements

Select which element provides the optimal temperature range

RTD element types

Platinum is the most widely specified RTD element type due to its wide temperature range, stability, and standardization between manufacturers. Copper, nickel, and nickel-iron can offer comparable accuracy at lower cost in many applications.

| Element material | Temperature range | Benefits | Typical base resistance | Sensitivity (Avg. W/°C, 0 to 100°C) | TCR Ω/Ω/°C |
|------------------|--------------------------------|--|--|-------------------------------------|---------------------|
| Platinum | -260 to 650°C (-436 to 1202°F) | <ul style="list-style-type: none"> • Greatest range • Best stability • Good linearity | 100 Ω at 0°C 1000 Ω at 0°C | 0.39 3.90 | 0.00375 to 0.003927 |
| Copper | -100 to 260°C (-148 to 500°F) | <ul style="list-style-type: none"> • Best linearity | 10 Ω at 25°C | 0.04 | 0.00427 |
| Nickel | -100 to 260°C (-148 to 500°F) | <ul style="list-style-type: none"> • Low cost • High sensitivity | 100 Ω at 0°C 120 Ω at 0°C | 0.62 0.81 | 0.00618 0.00672 |
| Nickel-iron | -100 to 204°C (-148 to 400°F) | <ul style="list-style-type: none"> • Low cost • Highest sensitivity | 604 Ω at 0°C 1000 Ω at 70°F 2000 Ω at 70°F | 3.13 4.79 9.58 | 0.00518 to 0.00527 |

RTD and thermistor interchangeability

The tables below show temperature tolerance — the allowable deviation from nominal curves — for RTDs and thermistors in this guide. Minco can supply sensors with tighter overall tolerance, or with the narrowest tolerance at a point other than 0°C.

| Temperature (°C) | Platinum RTD | | | | | |
|------------------|------------------------|-----------------------|--------------|--------------|--------------|---------------|
| | 0.06% at 0°C (Class A) | 0.1% at 0°C (Class B) | 0.22% at 0°C | 0.36% at 0°C | 0.1% at 70°F | 0.24% at 70°F |
| -200 | ±0.55°C | ±1.3°C | | | ±2.1°C | |
| -100 | ±0.35°C | ±0.8°C | ±1.3°C | | ±1.7°C | |
| 0 | ±0.15°C | ±0.3°C | ±0.5°C | ±0.9°C | ±1.3°C | ±0.7°C |
| 20 | ±0.19°C | ±0.4°C | ±0.7°C | ±1.3°C | ±1.6°C | ±0.6°C |
| 100 | ±0.35°C | ±0.8°C | ±1.8°C | ±2.3°C | ±2.9°C | ±1.1°C |
| 200 | ±0.55°C | ±1.3°C | ±3.1°C | ±3.7°C | ±4.4°C | ±1.8°C |
| 260 | ±0.67°C | ±1.6°C | ±3.7°C | ±4.6°C | ±5.5°C | |
| 300 | ±0.75°C | ±1.8°C | | | | |
| 400 | ±0.95°C | ±2.3°C | | | | |
| 500 | ±1.15°C | ±2.8°C | | | | |
| 600 | ±1.35°C | ±3.3°C | | | | |
| 700 | | ±3.8°C | | | | |
| 800 | | ±4.3°C | | | | |
| 850 | | ±4.6°C | | | | |

Thermocouple limits of error per NBS (NIST/SI) Monograph 17, based on ITS-90

| Junction Type | Limits of Error |
|------------------------|---------------------------------|
| E (Chromel-Constantan) | ±1.7°C or ±0.5% 0 to 900°C |
| J (Iron-Constantan) | ±2.2°C or ±0.75% 0 to 750°C |
| K (Chromel-Alumel) | ±2.2°C or ±0.75% 0 to 1250°C |
| T (Copper-Constantan) | ±1.0°C or ±0.75% 0 to 350°C |

| Temperature (°C) | Copper RTD | | Nickel RTD | | Nickel-iron RTD | | | | Thermistor | |
|------------------|---------------|---------------|---------------|--------------|-----------------|--------------|---------------|----------------|----------------|--------------|
| | ±0.2% at 25°C | ±0.5% at 25°C | ±0.3% at 25°C | ±0.5% at 0°C | ±0.26% at 0°C | ±0.5% at 0°C | ±0.5% at 25°C | ±0.12% at 70°C | ±0.25% at 70°C | ±0.1% at 0°C |
| -100 | ±1.5°C | ±2.2°C | | | | ±2.5°C | ±2.9°C | | | |
| 0 | ±0.7°C | ±1.5°C | ±0.5°C | ±0.8°C | ±0.6°C | ±1.1°C | ±1.4°C | ±0.5°C | ±1.4°C | ±0.2°C |
| 20 | ±0.5°C | ±1.3°C | ±0.8°C | ±1.2°C | ±0.8°C | ±1.4°C | ±1.2°C | ±0.3°C | ±0.7°C | ±0.2°C |
| 100 | ±1.5°C | ±2.5°C | ±1.8°C | ±2.2°C | ±1.7°C | ±2.4°C | ±2.2°C | ±1.1°C | ±2.0°C | ±0.3°C |
| 150 | ±2.2°C | ±3.3°C | ±2.5°C | ±3.0°C | ±2.3°C | ±3.1°C | ±2.9°C | ±1.6°C | ±2.9°C | ±1.0°C |
| 200 | ±2.8°C | ±4.1°C | ±3.1°C | ±3.7°C | ±2.9°C | ±3.8°C | ±3.6°C | ±2.1°C | ±3.8°C | |
| 260 | ±3.6°C | ±5.1°C | ±3.4°C | ±4.0°C | | | | | | |

RTD Connections: 2-Wire, 3-Wire, 4-Wire?

Compensate for leadwire resistance

Overview

Because an RTD is a resistance type sensor, resistance introduced by connecting copper extension wires between the RTD and control instrument will add to readings. Furthermore, this additional resistance is not constant but increases with ambient temperature. To estimate leadwire error in 2-wire circuits, multiply the total length of the extension leads times the resistance per foot in the table below. Then divide by the sensitivity of the RTD, given in the next two pages, to obtain an error figure in °C. For example, assume you have connected 100 feet of AWG 22 wires to a 100 Ω platinum RTD (PD element). Lead resistance is:

$$R = (200 \text{ ft.}) \times (0.0165 \text{ } \Omega / \text{ft.}) = 3.3 \text{ } \Omega$$

Approximate error is:

$$E = \frac{3.3 \text{ } \Omega}{0.385 \text{ } \Omega / \text{ } ^\circ\text{C}} = 8.6 \text{ } ^\circ\text{C}$$

| Copper Leadwire AWG | Ohms/ft. at 25°C |
|---------------------|------------------|
| 12 | 0.0016 |
| 14 | 0.0026 |
| 16 | 0.0041 |
| 18 | 0.0065 |
| 20 | 0.0103 |
| 22 | 0.0165 |
| 24 | 0.0262 |
| 26 | 0.0418 |
| 28 | 0.0666 |
| 30 | 0.1058 |

You can reduce leadwire error by:

- Using larger gauge extension wires.
- Specifying an RTD with greater sensitivity; 1000 Ω instead of 100 Ω, for example.
- Employing a 3 or 4-wire resistance canceling circuit as shown at right. Common leads, connected to the same end of the sensing element, are the same color.
- Using a 2-wire current transmitter. Its linearized signal is immune to electrical noise as well as resistance and can maintain accuracy over runs of several thousand feet. See page 40 for more information on temperature transmitters.

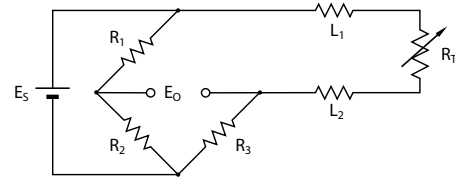

2-wire circuit

Shown above is a 2-wire RTD connected to a typical Wheatstone bridge circuit. ES is the supply voltage; EO is the output voltage; R1, R2, and R3 are fixed resistors; and RT is the RTD. In this uncompensated circuit, lead resistances L1 and L2 add directly to RT.

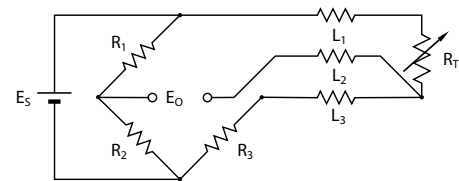

3-wire circuit

In this circuit there are three leads coming from the RTD instead of two. L1 and L3 carry the measuring current while L2 acts only as a potential lead. No current flows through it while the bridge is in balance. Since L1 and L3 are in separate arms of the bridge, resistance is canceled. This circuit assumes high impedance at EO and close matching of resistance between wires L1 and L3. Minco matches RTD leads within 5%.

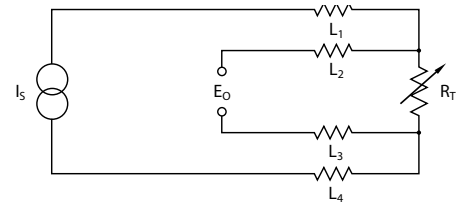

4-wire circuit

4-wire RTD circuits not only cancel leadwires but remove the effects of mismatched resistances such as contact points. A common version is the constant current circuit shown above. IS drives a precise measuring current through L1 and L4. L2 and L3 measure the voltage drop across the RTD element. EO must have high impedance to prevent current flow in the potential leads. 4-wire circuits may be usable over longer distances than 3-wire, but you should consider using a transmitter in electrically noisy environments.

If necessary you can connect a 2-wire RTD to a 3-wire circuit or 4-wire circuit, as shown to the right. As long as the junctions are near the RTD, as in a connection head, errors are negligible.

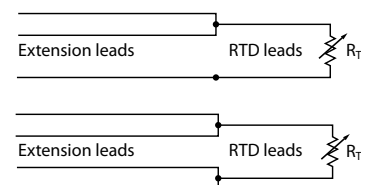

Resistance/Temperature Tables

Element resistance versus application temperature

| Platinum elements | | | | | | | | | | | | |
|----------------------------|-------------------|---------|---------|-------------|---------|---------|---------|---------|---------|---------|---------|---------|
| Element code | PJ | PA | PB | PM, PD, PE* | PN | PL | PH | PP | PG | PF | PW | PS |
| Resistance at 0°C | 25.5 Ω | 100 Ω | 100 Ω | 100 Ω | 200 Ω | 470 Ω | 500 Ω | 500 Ω | 500 Ω | 1000 Ω | 1000 Ω | 10k Ω |
| TCR (Ω/Ω/°C) | 0.00392 | 0.00392 | 0.00391 | 0.00385 | 0.00385 | 0.00392 | 0.00392 | 0.00391 | 0.00385 | 0.00385 | 0.00375 | 0.00385 |
| Sensitivity (Average Ω/°C) | 0.1 | 0.392 | 0.391 | 0.385 | 0.77 | 1.845 | 1.963 | 1.955 | 1.925 | 3.85 | 3.75 | 38.5 |
| Temperature (°C) | Resistance (ohms) | | | | | | | | | | | |
| -200 | 4.33 | 17.00 | 17.26 | 18.52 | 37.04 | 79.88 | 84.98 | 86.30 | 92.60 | 185.20 | | 1,852 |
| -180 | 6.56 | 25.72 | 25.97 | 27.10 | 54.19 | 120.88 | 128.59 | 129.84 | 135.48 | 270.96 | | 2,710 |
| -160 | 8.75 | 34.31 | 34.54 | 35.54 | 71.09 | 161.28 | 171.57 | 172.72 | 177.72 | 355.43 | | 3,554 |
| -140 | 10.91 | 42.80 | 43.01 | 43.88 | 87.75 | 201.15 | 213.99 | 215.03 | 219.38 | 438.76 | | 4,388 |
| -120 | 13.05 | 51.19 | 51.37 | 52.11 | 104.22 | 240.57 | 255.93 | 256.83 | 260.55 | 521.10 | | 5,211 |
| -100 | 15.17 | 59.49 | 59.64 | 60.26 | 120.51 | 279.58 | 297.43 | 298.19 | 301.28 | 602.56 | | 6,026 |
| -80 | 17.27 | 67.71 | 67.83 | 68.33 | 136.65 | 318.23 | 338.55 | 339.17 | 341.63 | 683.25 | | 6,833 |
| -60 | 19.35 | 75.87 | 75.96 | 76.33 | 152.66 | 356.57 | 379.53 | 379.80 | 381.64 | 763.28 | | 7,633 |
| -40 | 21.41 | 83.96 | 84.03 | 84.27 | 168.54 | 394.63 | 419.82 | 420.13 | 421.35 | 842.71 | 846.57 | 8,427 |
| -20 | 23.46 | 92.01 | 92.04 | 92.16 | 184.32 | 432.43 | 460.03 | 460.19 | 460.80 | 921.60 | 923.55 | 9,216 |
| 0 | 25.50 | 100.00 | 100.00 | 100.00 | 200.00 | 470.00 | 500.00 | 500.00 | 500.00 | 1000.00 | 1000.00 | 10,000 |
| 20 | 27.53 | 107.95 | 107.92 | 107.79 | 215.59 | 507.35 | 539.73 | 539.58 | 538.96 | 1077.94 | 1075.96 | 10,779 |
| 40 | 29.54 | 115.85 | 115.78 | 115.54 | 231.08 | 544.47 | 579.23 | 578.92 | 577.70 | 1155.41 | 1151.44 | 11,554 |
| 60 | 31.54 | 123.70 | 123.60 | 123.24 | 246.48 | 581.38 | 618.49 | 618.02 | 616.21 | 1232.42 | 1226.44 | 12,324 |
| 80 | 33.53 | 131.50 | 131.38 | 130.90 | 261.79 | 618.06 | 657.51 | 656.90 | 654.48 | 1308.97 | 1300.96 | 13,090 |
| 100 | 35.51 | 139.26 | 139.11 | 138.51 | 277.01 | 654.53 | 696.31 | 695.54 | 692.53 | 1385.06 | 1375.00 | 13,851 |
| 120 | 37.48 | 146.97 | 146.79 | 146.07 | 292.14 | 690.77 | 734.86 | 733.94 | 730.34 | 1460.68 | 1448.56 | 14,607 |
| 140 | 39.43 | 154.64 | 154.42 | 153.58 | 307.17 | 726.79 | 773.18 | 772.11 | 767.92 | 1535.84 | 1521.63 | 15,358 |
| 160 | 41.37 | 162.25 | 162.01 | 161.05 | 322.11 | 762.59 | 811.27 | 810.05 | 805.27 | 1610.54 | 1594.22 | 16,105 |
| 180 | 43.31 | 169.82 | 169.55 | 168.48 | 336.96 | 798.18 | 849.12 | 847.75 | 842.39 | 1684.78 | 1666.33 | 16,848 |
| 200 | 45.22 | 177.35 | 177.04 | 175.86 | 351.71 | 833.54 | 886.74 | 885.22 | 879.28 | 1758.56 | 1737.96 | 17,586 |
| 220 | 47.13 | 184.82 | 184.49 | 183.19 | 366.38 | 868.68 | 924.12 | 922.46 | 915.94 | 1831.88 | 1809.11 | 18,319 |
| 240 | 49.02 | 192.25 | 191.89 | 190.47 | 380.95 | 903.59 | 961.27 | 959.46 | 952.36 | 1904.73 | 1879.78 | 19,047 |
| 260 | 50.91 | 199.64 | 199.24 | 197.71 | 395.42 | 938.29 | 998.18 | 996.22 | 988.56 | 1977.12 | 1949.96 | 19,771 |
| 280 | 52.78 | 206.97 | 206.55 | 204.91 | 409.81 | 972.77 | 1034.86 | 1032.76 | 1024.52 | 2049.05 | 2019.67 | 20,490 |
| 300 | 54.64 | 214.26 | 213.81 | 212.05 | 424.10 | 1007.03 | 1071.31 | 1069.06 | 1060.26 | 2120.52 | 2088.89 | 21,205 |
| 320 | 56.48 | 221.50 | 221.02 | 219.15 | 438.30 | 1041.06 | 1107.51 | 1105.12 | 1095.76 | 2191.52 | 2157.63 | 21,915 |
| 340 | 58.32 | 228.70 | 228.19 | 226.21 | 452.41 | 1074.88 | 1143.49 | 1140.95 | 1131.03 | 2262.06 | 2225.89 | 22,621 |
| 360 | 60.14 | 235.85 | 235.31 | 233.21 | 466.43 | 1108.47 | 1179.23 | 1176.55 | 1166.07 | 2332.14 | 2293.67 | 23,321 |
| 380 | 61.95 | 242.95 | 242.38 | 240.18 | 480.35 | 1141.85 | 1214.73 | 1211.91 | 1200.88 | 2401.76 | 2360.96 | 24,018 |
| 400 | 63.75 | 250.00 | 249.41 | 247.09 | 494.18 | 1175.00 | 1250.00 | 1247.04 | 1235.46 | 2470.92 | 2427.78 | 24,709 |
| 420 | 65.54 | 257.01 | 256.39 | 253.96 | 507.92 | 1207.93 | 1285.03 | 1281.94 | 1269.81 | 2539.62 | 2494.11 | 25,396 |
| 440 | 67.31 | 263.97 | 263.32 | 260.79 | 521.57 | 1240.64 | 1319.83 | 1316.60 | 1303.92 | 2607.85 | 2559.96 | 26,078 |
| 460 | 69.07 | 270.88 | 270.21 | 267.56 | 535.12 | 1273.14 | 1354.40 | 1351.03 | 1337.81 | 2675.62 | 2625.33 | 26,756 |
| 480 | 70.83 | 277.75 | 277.04 | 274.29 | 548.59 | 1305.41 | 1388.73 | 1385.22 | 1371.46 | 2742.93 | 2690.22 | 27,429 |
| 500 | 72.56 | 284.57 | 283.84 | 280.98 | 561.96 | 1337.46 | 1422.83 | 1419.18 | 1404.89 | 2809.78 | 2754.63 | 28,098 |
| 520 | 74.29 | 291.34 | 290.58 | 287.62 | 575.23 | 1369.28 | 1456.69 | 1452.91 | 1438.08 | 2876.16 | | 28,762 |
| 540 | 76.01 | 298.06 | 297.28 | 294.21 | 588.42 | 1400.89 | 1490.31 | 1486.40 | 1471.04 | 2942.08 | | 29,421 |
| 560 | 77.71 | 304.74 | 303.93 | 300.75 | 601.51 | 1432.28 | 1523.70 | 1519.66 | 1503.77 | 3007.54 | | 30,075 |
| 580 | 79.40 | 311.37 | 310.54 | 307.25 | 614.51 | 1463.45 | 1556.86 | 1552.68 | 1536.27 | 3072.54 | | 30,725 |
| 600 | 81.08 | 317.96 | 317.09 | 313.71 | 627.42 | 1494.39 | 1589.78 | 1585.47 | 1568.54 | 3137.08 | | 31,371 |
| 620 | 82.75 | 324.49 | 323.60 | 320.12 | 640.23 | 1525.12 | 1622.47 | 1618.02 | 1600.58 | 3201.16 | | |
| 640 | 84.40 | 330.98 | 330.07 | 326.48 | | 1555.62 | 1654.92 | 1650.35 | | | | |
| 660 | 86.04 | 337.43 | 336.49 | 332.79 | | 1585.91 | 1687.14 | 1682.43 | | | | |
| 680 | 87.67 | 343.82 | 342.86 | 339.06 | | 1615.97 | 1719.12 | 1714.29 | | | | |
| 700 | 89.29 | 350.17 | 349.18 | 345.28 | | 1645.81 | 1750.87 | 1745.91 | | | | |
| 720 | | | | 351.46 | | | | | | | | |
| 740 | | | | 357.59 | | | | | | | | |
| 760 | | | | 363.67 | | | | | | | | |
| 780 | | | | 369.71 | | | | | | | | |
| 800 | | | | 375.70 | | | | | | | | |
| 820 | | | | 381.65 | | | | | | | | |
| 840 | | | | 387.55 | | | | | | | | |
| 850 | | | | 390.48 | | | | | | | | |

* PD is the most common platinum sensor element used by industry. PE has a wider manufacturing tolerance than PD.
 Note: More element options and complete tables in 1°C or 1°F increments are available from Minco at www.minco.com/

◀ Resistance/Temperature Tables

Most RTD tables follow the modified Callendar-Van Dusen equation: $R_t = R_0 [1 + At + Bt^2 + Ct^3]$ or some variation thereof, where R_t is the modified resistance at temperature t , R_0 is the ice point resistance, and A , B , and C are coefficients describing a given thermometer. Download Minco's white paper entitled *Resistance Thermometry: Principles and Applications of Resistance Thermometers and Thermistors* at www.minco.com for a complete set of equations and coefficients for numerical calculation of resistance vs temperature.

RTD Tables (non-platinum)

| | Copper | Nickel | Nickel-iron | | | Thermistors | | | |
|----------------------------|-------------------|--------------|--------------|--------------|--------------|-----------------------|-----------------------|-----------------------|-----------------------|
| Element code | CA | NA | FA | FB | FC | TA | TB | TF | TK |
| Base resistance | 10 Ω at 25°C | 120 Ω at 0°C | 604 Ω at 0°C | 1K Ω at 70°F | 2K Ω at 70°F | 2552 Ω at 25°C | 10K Ω at 25°C | 50K Ω at 25°C | 10K Ω at 25°C |
| TCR (Ω/Ω/°C) | .00427 | .00672 | .00518 | .00527 | .00527 | $R_{25}/R_{125}=29.2$ | $R_{25}/R_{125}=23.5$ | $R_{25}/R_{125}=31.2$ | $R_{25}/R_{125}=26.6$ |
| Sensitivity (Average Ω/°C) | 0.039 | 0.806 | 3.133 | 4.788 | 9.576 | -72 | -287 | -1523 | -324 |
| Temperature (°C) | Resistance (ohms) | | | | | | | | |
| -100 | 5.128 | | 372.79 | | | | | | |
| -80 | 5.923 | 66.60 | 410.73 | | | 1660K | 3558K | | |
| -60 | 6.712 | 79.62 | 452.82 | | | 316.5K | 845.9K | | |
| -40 | 7.490 | 92.76 | 499.06 | | | 75.79K | 239.8K | 1380K | 348.9K |
| -20 | 8.263 | 106.15 | 549.46 | 826.90 | 1653.81 | 21.87K | 78.91K | 431.8K | 100.2K |
| 0 | 9.035 | 120.00 | 604.00 | 908.40 | 1816.81 | 7355 | 29.49K | 155.6K | 33.15K |
| 20 | 9.807 | 134.52 | 660.97 | 995.04 | 1990.09 | 2814 | 12.26K | 62.24K | 12.52K |
| 40 | 10.580 | 149.79 | 720.79 | 1086.49 | 2172.99 | 1200 | 5592 | 26.64K | 5323 |
| 60 | 11.352 | 165.90 | 783.45 | 1182.50 | 2365.01 | 560.3 | 2760 | 12.31K | 2510 |
| 80 | 12.124 | 182.84 | 848.97 | 1282.83 | 2565.66 | 282.7 | 1458 | 6117 | 1293 |
| 100 | 12.897 | 200.64 | 917.33 | 1387.21 | 2774.44 | 152.8 | 816.8 | 3256 | 718.5 |
| 120 | 13.669 | 219.29 | 988.54 | 1495.42 | 2990.84 | 87.7 | 481.8 | 1836 | 425.0 |
| 140 | 14.442 | 238.85 | 1062.60 | 1607.18 | 3214.37 | 53.0 | 297.2 | | |
| 160 | 15.217 | 259.30 | 1139.50 | 1722.26 | 3444.54 | | | | |
| 180 | 15.996 | 280.77 | 1219.26 | 1840.41 | 3680.84 | | | | |
| 200 | 16.776 | 303.46 | 1301.86 | 1961.38 | 3922.77 | | | | |
| 220 | 17.555 | 327.53 | | | | | | | |
| 240 | 18.335 | 353.14 | | | | | | | |
| 260 | 19.116 | 380.31 | | | | | | | |

Thermocouple Voltage/Temperature Tables

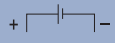
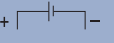
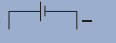
| Junction type | F - Chromel-Constantan +  Purple Red | J - Iron-Constantan +  White Red | K - Chromel-Alumel +  Yellow Red | T - Copper-Constantan +  Blue Red |
|---------------------|---|---|---|--|
| Sensitivity (mV/°C) | 0.063 | 0.053 | 0.041 | 0.043 |
| Temperature (°C) | Millivolts | | | |
| -200 | -8.824 | -7.890 | -5.891 | -5.603 |
| -150 | -7.279 | -6.499 | -4.912 | -4.648 |
| -100 | -5.237 | -4.632 | -3.553 | -3.378 |
| -50 | -2.787 | -2.431 | -1.889 | -1.819 |
| 0 | 0.000 | 0.000 | 0.000 | 0.000 |
| 50 | 3.047 | 2.585 | 2.022 | 2.035 |
| 100 | 6.317 | 5.268 | 4.095 | 4.277 |
| 150 | 9.787 | 8.008 | 6.137 | 6.702 |
| 200 | 13.419 | 10.777 | 8.137 | 9.286 |
| 250 | 17.178 | 13.553 | 10.151 | 12.011 |
| 300 | 21.033 | 16.325 | 12.207 | 14.860 |
| 350 | 24.961 | 19.089 | 14.292 | 17.816 |
| 400 | 28.943 | 21.846 | 16.395 | 20.869 |
| 450 | 32.960 | 24.607 | 18.513 | |
| 500 | 36.999 | 27.388 | 20.640 | |
| 550 | 41.045 | 30.210 | 22.772 | |

Temperature Coefficient of Resistance (TCR)

Differentiate elements by their resistance/temperature curves

Overview

TCR differentiates RTDs by their resistance/temperature curves. Sometimes called alpha (α), it is specified in various ways by different manufacturers.

In this guide TCR is the RTD's resistance change from 0 to 100°C, divided by the resistance at 0°C, divided by 100°C:

$$TCR (\Omega/\Omega/^\circ C) = \frac{R_{100^\circ C} - R_{0^\circ C}}{R_{0^\circ C} \times 100^\circ C}$$

For example, a platinum thermometer measuring 100 Ω at 0°C and 139.11 Ω at 100°C has TCR 0.00391 $\Omega/\Omega/^\circ C$:

$$TCR = \frac{139.11\Omega - 100\Omega}{100\Omega \times 100^\circ C} = .003911$$

For a copper RTD, 10 W at 25°C, TCR is:

$$TCR = \frac{12.897\Omega - 9.035\Omega}{9.035\Omega \times 100^\circ C} = 0.00427$$

Miscellaneous Specifications and Codes

Thread specification

| Thread | Applicable specifications |
|--|--|
| G ¹ / ₂ | ISO 228/1 DIN 259 BS 2779 JIS B0202 |
| R ¹ / ₄ R ¹ / ₈ | ISO 7/1 DIN 2999 BS 21 JIS B0203 |

Wire gauge conversion

| Copper Leadwire AWG | Cross sectional area mm ² | | Resistance Ω /ft. at 25°C |
|---------------------|--------------------------------------|-------|----------------------------------|
| | Stranded | Solid | |
| 30 | 0.057 | 0.051 | 0.1058 |
| 28 | 0.089 | 0.080 | 0.0666 |
| 26 | 0.141 | 0.128 | 0.0418 |
| 24 | 0.227 | 0.205 | 0.0262 |
| 22 | 0.355 | 0.324 | 0.0165 |
| 20 | 0.563 | 0.519 | 0.0103 |
| 18 | 0.897 | 0.823 | 0.0065 |

Stated another way, TCR is the average resistance increase per degree of a hypothetical RTD measuring 1 Ω at 0°C.

The most common use of TCR is to distinguish between curves for platinum, which is available with TCRs ranging from 0.00375 to 0.003927. The highest TCR indicates the highest purity platinum, and is mandated by ITS-90 for standard platinum thermometers.

There are no technical advantages of one TCR versus another in practical industrial applications. 0.00385 platinum is the most popular worldwide standard and is available in both wire-wound and thin-film elements.

In most cases, all you need to know about TCR is that it must be properly matched when replacing RTDs or connecting them to instruments.

SensorCalc Program

RTD and thermocouple tables are available online at www.minco.com

You can create and store tables in a variety of formats. You can also enter resistances and coefficients for custom tables, using Callendar-Van Dusen or ITS-90 equations.

Ingress Protection (IP) codes

| | First number Protection against solid bodies | Second number Protection from liquid |
|---|---|---|
| 0 | No protection | No protection |
| 1 | Objects > 50 mm | Vertically dripping water |
| 2 | Objects > 12 mm | 75° to 90° dripping water |
| 3 | Objects > 2.5 mm | Sprayed water |
| 4 | Objects > 1 mm | Splashed water |
| 5 | Dust-protected | Water jets |
| 6 | Dust-tight | Heavy seas |
| 7 | | Effects of immersion |
| 8 | | Indefinite immersion |

Approximate US enclosure type equivalent to IPXX

| Type | IP | Type | IP | Type | IP |
|------|----|--------|----|----------|----|
| 1 | 10 | 35 | 54 | 6 & 6P | 67 |
| 2 | 11 | 4 & 4X | 55 | 12 & 12K | 52 |
| 3 | 54 | 5 | 52 | 13 | 54 |
| 3R | 14 | | | | |

Frequently Asked Questions

Refer to these FAQs when configuring a sensing solution

What is the difference between Class A and Class B?

In the world of RTDs (Resistance Temperature Detectors), platinum has gained enormous popularity. This is due to the physical characteristics that make it superior to other materials for sensing temperature.

To provide interchangeability between manufacturers for the sake of global industry, there are some international standards that have been adopted by most countries:

IEC 60751 defines the temperature accuracy and the resistance/temperature characteristic curve for several tolerance classes

"Class B" and "Class A" are the most common tolerance classes. These are defined by a single nominal resistance/temperature characteristic curve and the following accuracy designations:

| Tolerance Class | Tolerance (°C) | Wire-wound construction* | Thin-film construction* |
|-----------------|------------------------|--------------------------|-------------------------|
| B | $\pm(0.3 + 0.005 t)$ | -196 to 600°C | -50 to 500°C |
| A | $\pm(0.15 + 0.002 t)$ | -100 to 450°C | -30 to 300°C |

*Consult sensor manufacturer for sensor construction of a particular model

There are a number of standards that either copy or are predecessors of IEC 60751. Among them are IEC 751, DIN 43760, EN 60751, and BS EN 60751. Another standard, ASTM E1137, uses the same nominal characteristic curve, but defines tolerances differently, and designates them as "Grade B" and "Grade A". The ASTM standard is not used as widely as the IEC standard.

Visit the RTD calculator on Minco.com to generate your specific temperature table.

When do I need shielded lead wires (electrical noise)?

Environments containing high voltages or in the presence of electromagnetic fields (EMF) may require shielded lead wires. These environments generate what is commonly referred to as "noise" (EMI) within a sensing instrument. Lead wires act as antennas.

Two common techniques may help alleviate the influence of electrical noise:

- Twisting the leads will help offset the induced noise.
- Lead wires may be covered with a "shielding," commonly silver plated copper braid (SPC Braid). Grounding the shielding at the instrument only provides the best results.

What are the differences between 2, 3, or 4 wire configurations?

RTDs (Resistance Temperature Detectors) are offered with 2, 3, or 4 lead configuration. The best configuration for a specific application depends on a number of factors, however the sensor configuration must match instrumentation, otherwise lead-wire resistance cancellation circuitry may be ineffective.

Factors to consider:

- **Cost of installation** – more wires generally means higher cost
- **Available space** – more or larger wires require more space
- **Accuracy requirements** – 2 wire configurations may provide the required accuracy, especially with high resistance elements

A. 2-lead constructions result in lead-wire resistance getting added to the element resistance. Consequently, the temperature reading is artificially high. The graph below shows the expected temperature error, from 2 leads of various sizes and lengths, for a 100-ohm platinum RTD at 100°C.

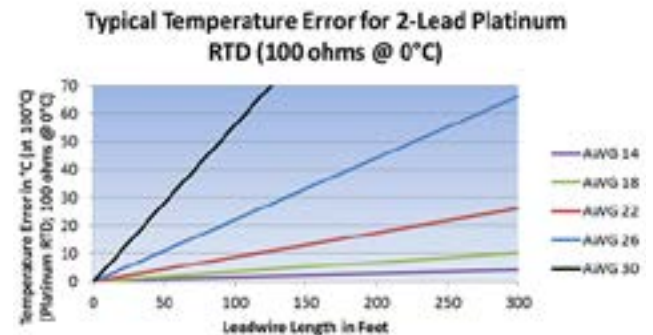

B. 3-lead constructions result in canceled lead-wire resistance error only if the instrumentation can measure true 3-wire resistance.

- Lead-wire resistance error cancellation is most effective when all the lead wires have the same resistance. Using 3 wires of the same AWG, length, and composition will typically result in lead-wire resistances matched within 5%. The graph below shows the maximum temperature error from lead-wire of various sizes and lengths, for a 3-lead 100-ohm platinum RTD at 100°C.

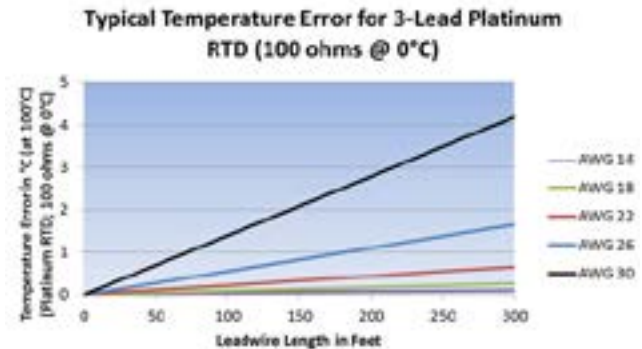

C. 4-lead constructions result in canceled resistance only if the instrumentation can measure true 4-wire resistance. True 4-wire resistance measurement will effectively cancel leadwire resistance error even if all 4 wires are not the same AWG, length, and/or composition.

Frequently Asked Questions

D. Are any configurations interchangeable?

Minco's RTDs can often be modified to work as a different type simply by modifying the leads:

- 4-lead RTDs can generally be used as 3-lead RTDs by eliminating (or tying off) one of the leads
- 4-lead RTDs can be used as 2-lead RTDs, by combining (shorting) the common leads (usually of like color – white/white and red/red)
- 3-lead RTDs can be used as 2-lead RTDs, by combining (shorting) the common leads (usually of like color)
- WARNING: combining the common leads eliminates lead-wire resistance cancellation benefits

E. See our "Resistance Thermometry" white paper on Minco.com for detailed analysis.

How do I know what type of alpha (TCR) curve to use?

TCR (Temperature Coefficient of Resistance) is the normalized average change in resistance of a sensing element over a specific temperature range (typically 0 to 100°C). The value is independent of the base resistance and is a characteristic of the element material itself. The units are measured in ohms/ohm/°C.

Example: A probe may read 100 ohms at 0°C, but at 100°C, the .00385 probe will read 138.5 ohms and the .00392 probe will read 139.20 ohms.

A. Resistance curve depends on instrumentation. Refer to your instrumentation manual for acceptable RTD (Resistance Temperature Detector) input types.

B. Common TCRs include:

| Material | Temperature Coefficient |
|-------------|---|
| Platinum | 0.00385 (EN 60751, IEC 751, DIN 43760, et al) |
| | 0.00391 (U.S. industrial standard) |
| | 0.00392 (highest purity platinum) |
| Copper | 0.00427 |
| Nickel-Iron | 0.00518 |
| | 0.00527 |

Should I use a grounded or ungrounded thermocouple?

A thermocouple is called "grounded" when the sensing junction is connected (physically and electrically) to the metal case. There are advantages and disadvantages but generally ungrounded thermocouples are preferable, providing a slower response time is acceptable.

| Thermocouple | Advantages | Disadvantages |
|--------------|--|---|
| Grounded | Provides intimate contact for a faster response time | Grounded tip construction is susceptible to induced noise from ground loops, resulting in a less accurate reading |
| Ungrounded | Provides a more accurate reading | Slower response time |

What is a cold (reference) junction for thermocouples?

Cold, or reference junction, is the end of a thermocouple that provides a reference point.

Thermocouples measure the difference in temperature between two junctions. They do NOT measure actual temperature. The sensing junction is where the thermocouple wires are welded (or otherwise connected) together, and located at a point where the temperature is desired. The other junction is typically located where it is connected to instrumentation (measuring device). This is known as the cold or reference junction. Thermocouple millivolt tables and mathematical formulas are based on a cold junction temperature of 0°C. To determine actual temperature, the instrumentation must "adjust" for the difference between ambient temperature and 0°C. This adjustment is known as cold junction compensation.

What type of potting do I use with bearing embedment sensors?

Embedment sensors are often potted with an epoxy compound. There are a variety of epoxies or compounds that will support specific applications.

Installers should consider:

- Temperature
- Service conditions
- Chemical compatibility with bearing shoe materials and oils

Minco has an array of embedment installation instructions that are available in the resource library of Minco's website. (EI 164, 167, 180, 181, 184)

Frequently Asked Questions

When do I need an electrically isolated probe?

To prevent an uncontrolled ground path, electrically isolated probes should be used in insulated bearings, where bearings may be electrically "hot".

Motors and generators may have insulated bearings to prevent electrostatic discharge and dissipate through a controlled path such as an earth brush. In this condition, a grounded probe may cause damage to the instrumentation as well as damage to the bearings.

How to specify an assembly (U length, Insertion Length, Probe Length, Etc)

Consult the following guidelines when specifying an assembly:

A. Insertion depth is used when an assembly does not utilize a thermowell. Defined as the distance including 50% of the process threads, down to the tip of the probe.

B. Probe length is the complete length of the probe including the length extended inside the connection head. Probe length is calculated by Insertion depth + fitting adder 'A'.

C. U length is used when an assembly utilizes a thermowell. Defined as the distance from the tip of the thermowell up to the beginning of the process threads.

D. Spring loaded holders offer a little length tolerance flexibility when combining these into an assembly.

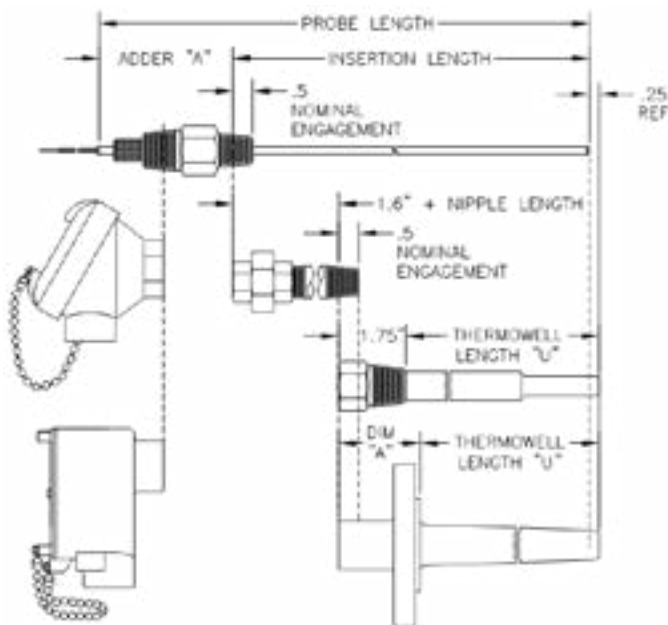

What size thermowell is appropriate for my application?

Based on the design of your system you need to know:

- Operating temperature (°C)
- Operating pressure (bar), Specific volume (m³/kg)
- Velocity (m/s)

Once those are established then you're ready to consult ASME standard PTC 19.3 TW-2010 Thermowell section, which goes through the calculation for the design of the well.

Here are some basic rules you can follow*:

- In general, higher flow velocity requires shorter thermowells.
- Make sure the thermowell material is compatible with the medium in which it is immersed.
- Economical welded thermowells may be used in low flow applications such as some HVAC chiller lines (typically less than 1-3 ft/sec).
- Tapered thermowells are typically better suited for high flow velocities than step (reduced-tip) thermowells.

*Because Minco's products are used in a wide variety of applications, the above information is provided for general consideration purposes only. Consult the expert for your specific application or end use prior to implementing any solution. Minco assumes no liability for damages resulting from this information provided.

How do I determine the chemical compatibility of Minco sensors?

Minco has identified a list of the least expensive materials that are compatible with various corrosive media. Unusual temperatures or levels of concentration should also be considered. The list is not comprehensive due to the extensive variety of applications in which Minco products are consumed. Minco encourages customers to perform additional validation for chemicals and materials not specified in the list.

You can find the Material Selection Guide list on Minco.com.

Temperature Sensors

Temperature Sensors

| | |
|---|----|
| Averaging Temperature Sensors..... | 16 |
| Chill-Out™ Combination Sensors | 17 |
| Duct & Outside Air Temperature Sensors | 19 |
| Elements & Probes | 20 |
| Refrigeration & Freezer Temperature System | 21 |
| Room Air Temperature Sensors..... | 22 |
| Thermal Vial Temperature Sensing System | 23 |
| Surface Mount Thermal Ribbon and Thermal Tab Sensors..... | 25 |
| Bolt-On Sensors..... | 29 |
| Economy Sensors | 30 |
| Fluid Immersion Temperature Sensors..... | 31 |
| Fast-Response RTDs..... | 32 |
| Fast-Response Immersion RTDs | 33 |
| Compact Plug Sensor | 34 |
| Integrated Sensor-Transmitter..... | 35 |

Averaging Temperature Sensors

Continuous element senses a true average temperature

Overview

Sense temperature of air streams in ducts and plenums. Sensors include a junction box with gasket to prevent leakage and vibration noise.

These sensors have a continuous element to sense true average temperature along their entire length. They provide accurate composite readings in locations where air may be stratified into hot and cold layers.

Rigid averaging sensors have a brass case. Bendable models have aluminum sheaths (copper on special order), formable to a radius of 4". Bendable sensors can criss-cross ducts to average temperatures in two dimensions.

See Instruments section for optional 4 to 20 mA temperature transmitters.

Specifications

Temperature range:

Probe: -45.5 to 135°C (-50 to 275°F).

Gasket: 100°C (212°F) max.

Leadwires: AWG 22, PTFE insulated, 8" (200 mm) long.

Moisture resistance: Meet MIL-STD-202, Method 104, Test Condition B.

Special options:

- Lengths to 100 feet (30m)
- Weatherproof connection box
- Sensor only, no box
- Thermistor averaging sensors

Standard model options

| RTDs | TCR Ω/Ω/ 0°C | Rigid averaging sensors | Bendable averaging sensors |
|---------------------------|-----------------|-------------------------------|----------------------------------|
| *Platinum 100Ω at 0°C | 0.00391 | S423PB | S447PB |
| *Platinum 100Ω at 0°C | 0.00385 | S456PE | S457PE |
| *Platinum 1000Ω at 0°C | 0.00385 | S493PF | S475PF |
| *Platinum 1000Ω at 0°C | 0.00375 | S492PW | S488PW |
| Nickel-iron 1000Ω at 70°F | 0.00527 | S421FB | S445FB |
| Nickel-iron 2000Ω at 70°F | 0.00527 | S422FC | S446FC |
| *HW 3000Ω at -30.2°C | 0.00262 | S20080PX | S15215PX |

* These averaging sensors use a proprietary sensing element that closely matches the platinum curve over the specified range.



Rigid averaging sensors

| S456PE | Model number from table |
|--------------------------------|--|
| Y | Number of leads: Y = 2 leads Z = 3 leads |
| | Insertion depth in inches: 12, 24, 48 are standard |
| 12 | |
| S456PEY12 = Sample part number | |

Bendable averaging sensors

| S457PE | Model number from table |
|--------------------------------|--|
| Z | Number of leads: Y = 2 leads Z = 3 leads |
| | Insertion length in feet: 12, 24, 50, 100 are standard |
| 24 | |
| S457PEZ24 = Sample part number | |

To order with transmitter, add

| | |
|-------|---|
| TT111 | Transmitter Models: TT111: Fixed Range (2 leads) TT211: Fixed Range (2 leads) TT321: Fixed Range (3 leads) <i>Other transmitter options available.</i> |
| | Temperature Range Code: A = 20F to 120F (-6.7C to 48.9C) <i>See pages 42-43 or contact Minco for a complete list of available temperature codes.</i> |
| A | Calibration: 1 = Nominal Calibration 2 = Match Calibrated, 0.75% Total System Accuracy 3 = Match Calibrated, 0.5% Total System Accuracy |
| | TT111A1 = Sample part number addition |

Chill-Out™ Combination Sensors

Combines a low-temperature cutout and an averaging temperature sensor

Overview

- Two sensors in one easily installed package: a solid state low temperature cut-out and an averaging 1000.0 Ω platinum temperature detector (RTD).
- Low temperature cut-out device that replaces the traditional labor intensive vapor filled devices. The Chill-Out™ Combination Sensor has two sensors in one reducing installed costs.
- Environmentally friendly “Green Design” uses solid state sensor construction, eliminating potential leaks and disposal issues with traditional refrigerant vapor-filled capillaries that could harm the environment.
- Solid state design and rugged 3/8” diameter tubing eliminate concerns of gas leaks or kinking of the capillary commonly encountered during the installation of traditional vapor filled devices.
- Mount in any direction—unit is sensitive to temperature changes in any orientation.
- Status LED: (green / red) multifunctional LED. Indicates power on and fault.
- Easily formed aluminum or highly flexible galvanized armor (PVC coated) plenum-rated sensor case.
- Manual reset: selectable latching and non-latching , remote reset may be used with latching mode.
- High and low power relays and adjustable setpoint control circuitry self contained in rugged housing.
- Detachable sensor probe for easy installation. Sensor can be mounted to back of enclosure or side.
- Fail-safe relays change state if power is lost and on startup.
- UL60730 Listed - File E211718.



Chill-Out combination sensors

| | |
|---|---|
| AS570 | Model number |
| PF | Element Type: PF = 1000 Ω RTD (0.00385 Platinum) and low temperature cut-out. |
| 8A | Case Length L in feet & Case Type: 8 = 8.0 feet. 8, 17, 25 & 50 are standard Available Options: A = Aluminum (0.375 Aluminum Tube) B = Galvanized (0.53 Galvanized Armor, PVC Coated) |
| | TO ORDER CHILL-OUT ONLY, WITHOUT OPTIONAL TRANSMITTER, STOP HERE. TO ORDER WITH OPTIONAL TRANSMITTER, ADD THE FOLLOWING ORDER INFORMATION: |
| 111 | Transmitter (Optional): 111 = TT111 (4 - 20 mA) |
| A | Transmitter Temp Range: A = 20°F to 120°F (-6.7°C to 48.9°C) <i>See list on pages 42-43 or contact Minco for a complete list of available temperature codes.</i> |
| AS570PF8A111A = Sample part number | |

Relay specifications

| Contact | Normally Open | | Normally Closed | |
|---------------------|---------------|---------|-----------------|---------|
| | 120 VAC | 240 VAC | 120 VAC | 240 VAC |
| AC Motor Voltage | 120 VAC | 240 VAC | 120 VAC | 240 VAC |
| AC Full Load Amp | 12 | 8 | 6 | 3 |
| AC Locked Rotor Amp | 96 | 48 | 36 | 18 |
| Pilot Duty | 125VA | 125VA | 125VA | 125VA |

Chill-Out Combination Sensors

Specifications

Specifications

Low Limit Cut-out: Accuracy $\pm 0.9^{\circ}\text{F}$ ($\pm 0.5^{\circ}\text{C}$) sensitive over any 12" area. Set Point adjustable on control board via dip switches from 30°F to 44°F (-1.1°C to 6.7°C)

Averaging RTD: 1000 Ω nominal at 0°C 0.00385 curve accuracy Class B

Operating temperature: -50°F to 176°F (-45.5°C to 80°C).

(Operating temperature for sensor -50°F to 176°F (-45.5°C to 80°C)).

Electronics inside enclosure 18°F to 122°F (-7.8°C to 50°C)

Sensor sheath: Bendable aluminum or Galvanized flexible Steel PVC coated UL 94V-0 and plenum rated.

Enclosure: Clear polycarbonate, flame retardant, tested to UL 94-5VA. Suitable for HVAC applications.

Power requirement: 24V \pm 5V AC or DC 200mA.

Installation: Unit is fully functional while mounted in any direction; Horizontal installation not required. All connections to the board are made using easy-to-connect pluggable terminal blocks.

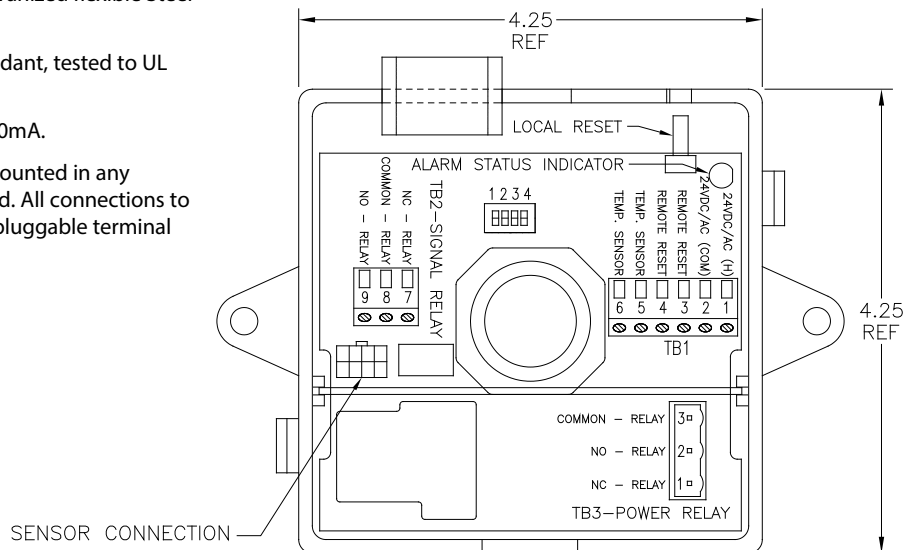
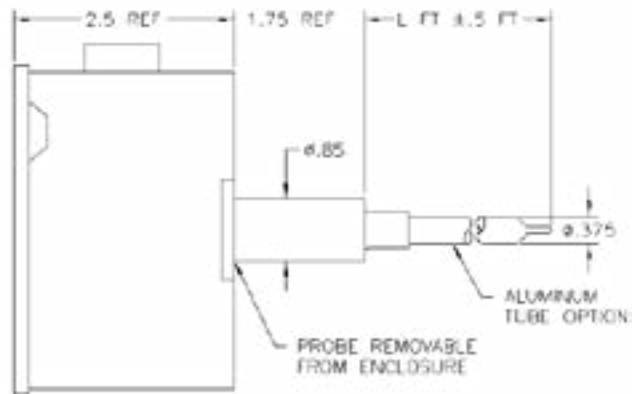

NOTE: View Relay Specifications to the

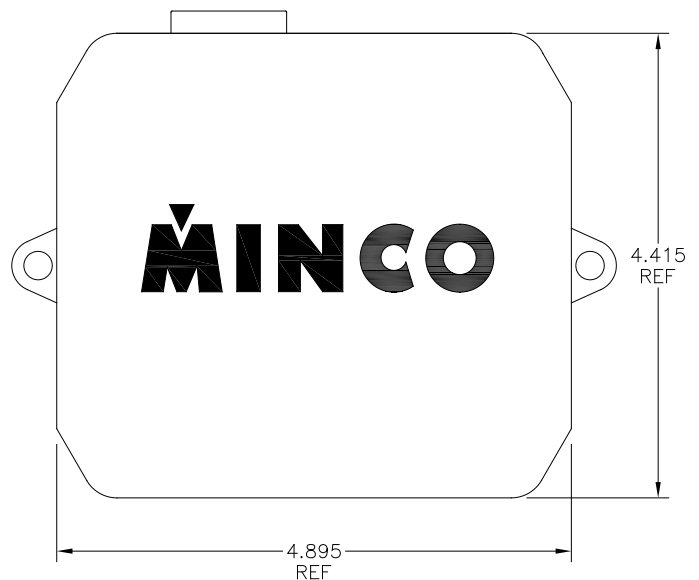

Duct and Outside Air Temperature Sensors

Sense air temperature in ducts and outside

Overview

Sense temperature of air streams in ducts and plenums. Sensors include a junction box with gasket to prevent leakage and vibration noise.

These point-sensing thermometers feature a fast-responding aluminum sensing tip.

Custom options include a weatherproof connection box and an all stainless steel probe.

Outside air sensors are designed to mount on conduit outside your building. They include an elbow type enclosure and sun shield.

See pages 36-44 for optional 4 to 20 mA temperature transmitters and other instruments.

Specifications

Temperature range:

Probe: -45.5 to 135°C (-50 to 275°F).

Gasket: 100°C (212°F) max.

Leadwires:

AWG 22, PTFE insulated,
4" (100 mm) long.

Moisture resistance:

Point sensors meet MIL-STD-202, Method 104, Test Condition B

Special options

- Weatherproof connection box
- All stainless steel probe

Model numbers

| | Element | TCR | Duct point sensors | Outside air sensors |
|--------------------|--|------------------|--------------------|---------------------|
| RTDs | | | | |
| Platinum | 100 Ω +/-0.1% at 0°C | 0.00391 | S408PB | S414PB |
| Platinum | 100 Ω +/-0.1% at 0°C (Meets EN60751, Class B) | 0.00385 | S450PD | S454PD |
| Platinum | 1000 Ω +/-0.1% at 0°C | 0.00385 | S451PF | S455PF |
| Platinum | 1000 Ω +/-0.1% at 0°C | 0.00375 | S484PW | S486PW |
| Nickel-iron | 1000 Ω +/-0.12% at 70°F | 0.00527 | S406FB | S412FB |
| Nickel-iron | 2000 Ω +/-0.12% at 70°F | 0.00527 | S407FC | S413FC |
| HW | 3000 Ω at -30.2°C | 0.00262 | S100060PX | S100062PX |
| Thermistors | | R_{25}/R_{125} | | |
| Thermistor | 2,252 Ω at +/-1% at 25°C | 29.2 | TS430TA | TS428TA |
| Thermistor | 10,000 Ω at +/-1% at 25°C | 23.5 | TS431TB | TS429TB |

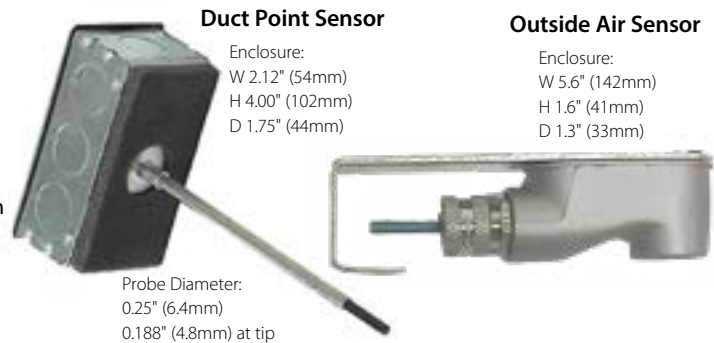

Duct Point Sensor

Enclosure:
W 2.12" (54mm)
H 4.00" (102mm)
D 1.75" (44mm)

Outside Air Sensor

Enclosure:
W 5.6" (142mm)
H 1.6" (41mm)
D 1.3" (33mm)

Probe Diameter:
0.25" (6.4mm)
0.188" (4.8mm) at tip

Duct point sensors

| S450PD | Model number from table |
|--------------------------------|--|
| Y | Number of leads: Y = 2 leads Z = 3 leads (RTD only) |
| 12 | Insertion depth in inches: 6,12,18 are standard Minimum: 3" |
| S450PDY12 = Sample part number | |

Outside air sensors

| S414PB | Model number from table |
|------------------------------|--|
| Z | Number of leads: Y = 2 leads Z = 3 leads (RTD only) |
| S414PBZ = Sample part number | |

To order with transmitter, add

| | |
|---------------------------------------|--|
| TT111 | Transmitter Models: TT111: Fixed Range (2 leads) TT211: Fixed Range (2 leads) TT321: Fixed Range (3 leads) <i>Other transmitter options available.</i> |
| A | Temperature Range Code: A = 20F to 120F (-6.7C to 48.9C) <i>See pages 42-43 or contact Minco for a complete list of available temperature codes.</i> |
| 1 | Calibration: 1 = Nominal Calibration 2 = Match Calibrated, 0.75% Total System Accuracy 3 = Match Calibrated, 0.5% Total System Accuracy 4 = Match Calibrated, 0.2% or 1°C Total System Accuracy. |
| TT111A1 = Sample part number addition | |

Elements and Probes

Fast-responding RTD or thermistor elements in cases

Overview

These models feature fast-responding RTD or thermistor elements in aluminum cases (except stainless steel on S482PW) with PTFE insulated leadwires. They can be assembled into probes or used separately as allpurpose sensors.

Probes consist of elements assembled into stainless steel extension tubes.

They are not suitable for direct fluid immersion but may be used with thermowells.

See page 40 for optional 4 to 20 mA temperature transmitters.

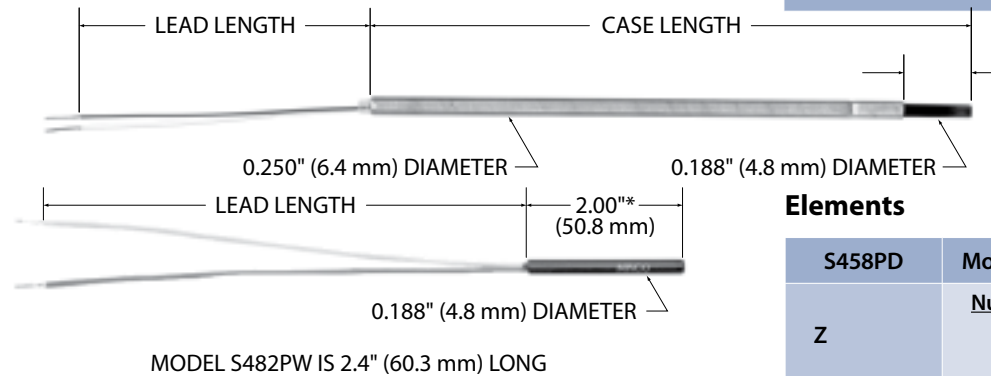

Specifications

Temperature range: -45.5 to 135°C (-50 to 275°F).

Leadwires: AWG 22, PTFE insulated. Standard lengths are 4", 12" and 18".

Moisture resistance: Meets MIL-STD-202, Method 104, Test Condition B.

Insulation resistance: 1000 megohms min. at 500 VDC, leads to case.

Model numbers

| | Element | TCR | Duct point sensors | Outside air sensors |
|--------------------|--|------------------|--------------------|---------------------|
| RTDs | | | | |
| Platinum | 100Ω +/-0.1% at 0°C | 0.00391 | S402PB | S411PB |
| Platinum | 100Ω +/-0.1% at 0°C (Meets EN60751, Class B) | 0.00385 | S458PD | S460PD |
| Platinum | 1000Ω +/-0.1% at 0°C | 0.00385 | S459PF | S461PF |
| Platinum | 1000Ω +/-0.1% at 0°C | 0.00375 | S482PW | S485PW |
| Nickel-iron | 1000Ω +/-0.12% at 70°F | 0.00527 | S400FB | S409FB |
| Nickel-iron | 2000Ω +/-0.12% at 70°F | 0.00527 | S401FC | S410FC |
| HW | 3000Ω at -30.2°C | 0.00262 | S100057PX | S100837PX |
| Thermistors | | R_{25}/R_{125} | | |
| Thermistor | 2,252Ω at +/-1% at 25°C | 29.2 | TS438TA | TS440TA |
| Thermistor | 10,000Ω at +/-1% at 25°C | 23.5 | TS439TB | TS441TB |

Probes

| S411PB | Model number from table |
|---------------------------------|--|
| 60 | Case length: Specify in 0.1" increments (Ex: 60 = 6.0 inches) Minimum length is 3" |
| Z | Number of leads: Y = 2 leads; Z = 3 leads (platinum only) |
| 4 | Lead length in inches: 4, 12, 18 |
| S411PB60Z4 = Sample part number | |

Elements

| S458PD | Model number from table |
|-------------------------------|---|
| Z | Number of leads: Y = 2 leads Z = 3 leads (platinum only) |
| 4 | Lead length in inches |
| S458PDZ4 = Sample part number | |

To order with transmitter, add

| | |
|---------------------------------------|--|
| TT111 | Transmitter Models: TT111: Fixed Range (2 leads) TT211: Fixed Range (2 leads) TT321: Fixed Range (3 leads) <i>Other transmitter options available.</i> |
| A | Temperature Range Code: A = 20F to 120F (-6.7C to 48.9C) <i>See pages 42-43 or contact Minco for a complete list of available temperature codes.</i> |
| 1 | Calibration: 1 = Nominal Calibration 2 = Match Calibrated, 0.75% Total System Accuracy 3 = Match Calibrated, 0.5% Total System Accuracy 4 = Match Calibrated, 0.2% or 1C Total System Accuracy |
| TT111A1 = Sample part number addition | |

Refrigeration & Freezer Temperature System

Accurate, rugged, and weatherproof temperature sensors

Overview

- Ideal for refrigerated rooms, freezers, cold storage facilities and laboratories — anywhere an accurate, rugged, and weatherproof temperature sensor is needed.
- 100 Ω platinum RTD probe is constructed of 316 stainless steel to be resistant to most chemicals, including ammonia.
- Operates to -452°F (-269°C).
- 4 to 20 mA transmitter is epoxy potted to protect circuitry from condensation and ice. Operates in ambient temperatures down to -13°F (-25°C).
- Transmitter is match calibrated to RTD for 0.75% system accuracy. Free NIST/SI certificate.
- Enclosure is gasketed and moisture resistant.
- RTD probe is available in lengths ranging from 2 inches to 48 inches, and the probe can be center-mounted for through-the-wall installation, or end-mounted for flush-to-the-wall mounting.

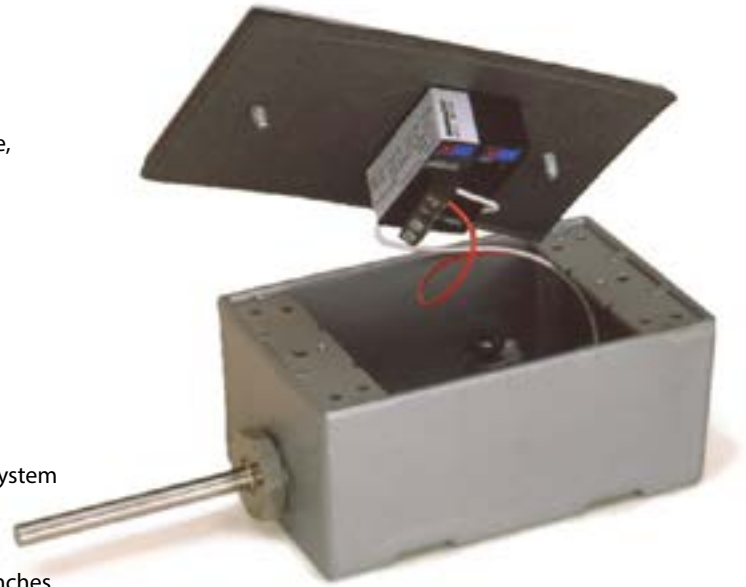

Specifications

Temperature range:

Probe: -269 to 260°C (-452 to 500°F).

Transmitter: -25 to 85°C (-13 to 185°F).

RTD probe: 100 Ω platinum, 0.00385 TCR.

Transmitter: 4-20 mA output, 8.5 to 35 VDC loop powered.

| | |
|------------------------------------|---|
| AS100279 | Model number |
| PD | 100 Ω platinum RTD |
| 67 | Probe length: Specify in 0.1" increments (Ex: 67 = 6.7 inches) |
| M | Temperature range for 4-20 mA output: M = -50 to 50°C (-58 to 122°F) AD = -40 to 48.9°C (-40 to 120°F) DN = -30 to 50°C (-22 to 122°F) S = -18 to 37.8°C (0 to 100°F) BY = -10 to 40°C (14 to 104°F) <i>See pages 42-43 for more ranges or check on Minco.com.</i> |
| AS100279PD67M = Sample part number | |

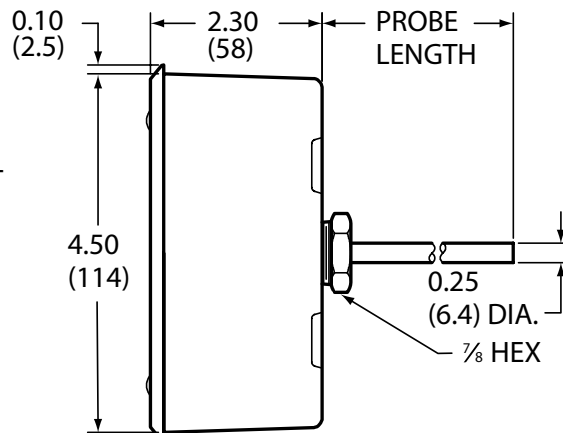
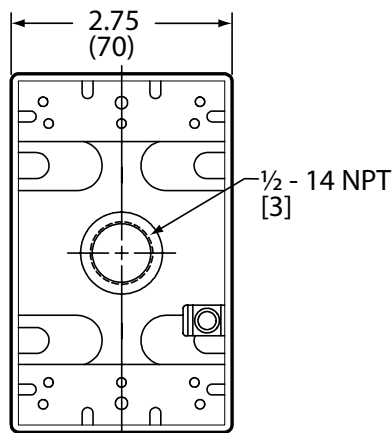

Room Air Temperature Sensors

Wall-mounted sensors

Compact Wall-mount

Dimensions:
W 3.12" (79mm)
H 2.09" (54mm)
D 1.80" (46mm)



Full-Size Wall-mount

Dimensions:
W 2.75" (70mm)
H 4.50" (114mm)
D 1.56" (40mm)



Explosionproof Wall-mount

Dimensions:
W 1.60" (41mm)
H 5.55" (141mm)
D 2.05" (52mm)



Flush Wall-mount

Dimensions:
W 2.75" (70mm)
H 4.50" (114mm)
D 0.18" (5mm)



Moisture resistance: Meets MIL-STD-202, Method 104, Test Condition B.

Transmitters: Full size sensors with 2 leads can use Tempran transmitter model TT115 installed within the sensor enclosure. A variety of transmitters are available for all other sensor models with transmitters installed in a separate enclosure from the sensor.

Overview

Minco's room air sensors are available with a variety of enclosures that meet most standard and explosion-proof HVAC/R installations. The sensors can be match calibrated with a Minco Tempran temperature transmitter for increased accuracy and reliability.

Room air sensors are designed for wall mounting. Choose from two plastic enclosure styles with brushed aluminum faceplates or a flush-mount stainless steel model.

The full-size enclosure and flushmount fit over standard junction boxes. The full size enclosure has optional knockouts for Wiremold raceway surface wiring. Just remove knockouts with pliers. This enclosure may also include a 4-20 mA temperature transmitter; specify model AS200655.

The explosion-proof sensor housing is UL listed and CSA approved for Class I, Groups C and D; Class II, Groups E, F, and G; and Class III. Download Application Aid #19 for more hazardous area information and the various standards and agencies (including FM, CSA, and ATEX) at www.minco.com.

Specifications

Temperature range:

-45.5 to 100°C (-50 to 212°F)

Temperature range (with TT115 transmitter):

Zero: -40 to 10°C (-40 to 50°F)

Span: 25 to 100°C (45 to 180°F)

Max upper temperature: 85°C (185°F)

Leadwires:

Full size and compact: AWG 22, PTFE insulated, 4" (100 mm) long.

Explosion-proof and flush mount: AWG 26, PTFE insulated, 6" (150 mm) inside cover.

Specification and order options

| S472PB | Model number from table |
|---------------------------------|--|
| Y | Number of leads: Y = 2 leads Z = 3 leads |
| | Lead length in inches: 4 |
| 4 | |
| K0 | Knockouts (full size only): K0 = No knockouts K1 = Knockouts for Wiremold raceway |
| | |
| S472PBY4K0 = Sample part number | |

| S100147PD | Model number from table |
|---------------------------------|---|
| Y | Number of leads: Y = 2 leads Z = 3 leads |
| | |
| S100147PDY = Sample part number | |

| Element | TCR | Compact wall-mount sensors | Full-size wall-mount sensors | Explosionproof wall-mount sensors | Flush wall-mount sensors |
|--|---|----------------------------|------------------------------|-----------------------------------|--------------------------|
| RTDs | | | | | |
| Platinum 100 Ω +/-0.1% at 0°C | 0.00391 | S405PB | S472PB | | |
| Platinum 100 Ω +/-0.1% at 0°C (Meets EN60751, Class B) | 0.00385 | S448PD | S473PD | S100147PD | S101456PD |
| Platinum 1000 Ω +/-0.1% at 0°C | 0.00385 | S449PF | S474PF | S100148PF | S101456PF |
| Platinum 1000 Ω +/-0.1% at 0°C | 0.00375 | S483PW | S489PW | S101608PW | S101456PW |
| Nickel-iron 1000 Ω +/-0.12% at 70°F | 0.00527 | S403FB | S470PB | | |
| Nickel-iron 2000 Ω +/-0.12% at 70°F | 0.00527 | S404FC | S471FC | | |
| HW 3000 Ω at -30.2°C | 0.00262 | S100064PX | S100063PX | | |
| Thermistors | | | | | |
| Thermistor 2,252 Ω at +/-1% at 25°C | R ₂₅ /R ₁₂₅ 29.2 | TS426TA | TS424TA | TS100149TA | TS101769A |
| Thermistor 10,000 Ω at +/-1% at 25°C | 23.5 | TS427TB | TS425TB | TS100150TB | TS101769TB |

Thermal Vial™ Temperature Sensing System

Measure the temperature of the contents, not the air



Overview

- Ideal for ultralow freezers, laboratories, blood banks, walk-in freezers and refrigerators, even incubators—anywhere accurate sensing of the contents instead of the air is a vital concern.
- Sealed Polyethylene Thermal Vial™ eliminates spillage and contamination. Simply fill with fluid such as ethylene glycol, alcohol, water, or a cryopreservative to accurately emulate the material being stored or processed.
- Large (50 mm x 50 mm) footprint of the single well vial provides stability on a shelf or rack. Holds 175 ml (6 oz) of fluid. Other vial configurations are available.
- Platinum RTD probe is constructed of 316 Stainless Steel and operates to -200°C (-328°F).
- Metal shielded cable is rugged and washdown proof.
- 4 to 20 mA transmitter is match calibrated to the RTD for improved system accuracy.
- NIST/SI certificate and calibration data supplied at no additional cost.
- Additional accessories available.
- Customizable for validation requirements.
- Connection box and indicator are polycarbonate and NEMA 4X sealed to be washdown proof.

Specification and order options

| | |
|--|--|
| AS103282 | Model number |
| PM | Sensing element, .00385 TCR: PM = 100Ω Platinum +/-0.06%, Class A PD = 100Ω Platinum +/-0.12%, Class B PF = 1000Ω Platinum +/-0.12% |
| 60 | Cable length in inches: 60, 120 are standard |
| D | Vial configuration: S = Single thermowell, standard vial D = Dual thermowell T = Triple thermowell M = Single thermowell, miniature vial L = Single thermowell, large vial |
| C | Connection box type: C = Indicating °C F = Indicating °F B = Non-indicating |
| 20 | System accuracy: 20 = .20% of span or .1°C, whichever is greater 50 = .50% of span 75 = .75% of span |
| EZ | Temptran temperature range code: EZ = -100/0°C (-148/32°F) M = -50/50°C (-58/122°F) C = 0/100°C (32/212°F) |
| See pages 42-43 or contact Minco for a complete list of available temperature codes. | |
| AS103282PM60DC20EZ = Sample part number | |

Thermal Vial Temperature Sensing System

Technical Details and accessories

Technical Details

Probe case: Stainless steel.

Element: Platinum.

Resistance (excluding leadwire resistance):

PM platinum: 100.00 $\Omega \pm 0.06\%$ at 0°C (32°F) (Class A).

PD platinum: 100.00 $\Omega \pm 0.12\%$ at 0°C (32°F) (Class B).

PF platinum: 1000.00 $\Omega \pm 0.12\%$ at 0°C (32°F).

TCR: .00385 $\Omega/\Omega/^\circ\text{C}$ nominal from 0°C to 100°C.

Operating temperature range:

Probe and vial: -200 to 120°C (-328 to 248°F).

Transmitter: -25 to 85°C (-13 to 185°F).

Insulation resistance: 1000 megohms minimum at 500 VDC, leads to probe case.

Leads: AWG #22, stranded, TFE insulated, with TFE jacket overall.

Thermal vial: Polyethylene bottle with cap.

Thermowell: Delrin material.

Transmitter: 4-20 mA output; 8.5 to 35 VDC loop powered.

Connection box: Polycarbonate enclosure, NEMA 4X.

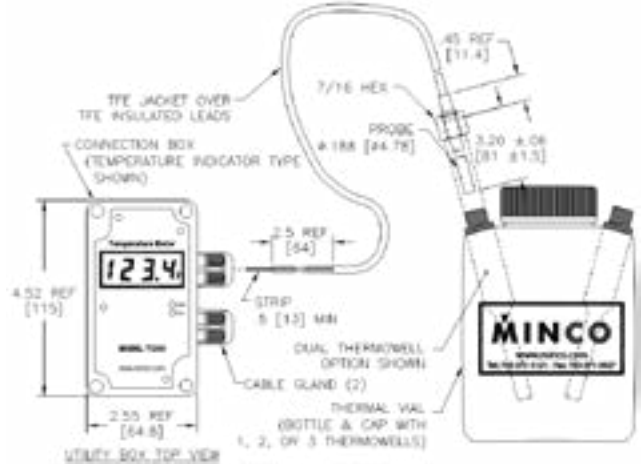

Bottle accessories

| Description | Capacity | | Model |
|-------------|----------|--------|----------|
| Single | 6 oz. | 175ml | AC101394 |
| Double | 8 oz. | 250ml | AC102026 |
| Triple | 8 oz. | 250ml | AC102647 |
| Mini | 2 oz. | 60ml | AC103316 |
| Large | 32 oz. | 1000ml | AC102551 |

Bracket accessories

| Description | Model |
|----------------------------|----------|
| Single well bracket | AC101540 |
| Double/triple well bracket | AC102732 |
| Air sensor bracket | AC102074 |



Junction box accessories

| Description | Model |
|-------------------------|----------|
| Loop-powered indicating | TI350 |
| Non-indicating | CH102777 |

Thermal-Tab™ and Thermal-Ribbon Sensors

Fast and accurate surface sensing

Overview

Minco's Thermal-Tab and Thermal-Ribbon sensors can be installed virtually anywhere for accurate temperature sensing and fast response in aerospace, medical, and industrial devices. These thin, flexible RTDs and thermocouples are surface or pressure sensitive mounted to be non-invasive and track rapidly changing conditions in both point and averaging configurations. Our Thermal-Ribbon sensors are made with polyimide, silicone rubber, and other high performing insulation and can be waterproof constructed for continuous immersion.

Options include stainless steel braid over leadwires to prevent abrasion damage and pressure-sensitive adhesive for easier mounting (smooth surfaces only). See pages 36-44 for optional 4 to 20 mA temperature transmitters and other instruments.

Install these compact sensors anywhere for accurate point sensing and fast response. All Thermal-Tab modules use a thin-film RTD element. All Thermal-Ribbon models conform to EN60751 Class B tolerance when ordered with a PD platinum element.

- Non-invasive pipe measurement for heated pipes or chiller lines.
- Fast response surface sensing in aerospace, medical and industrial devices
- Rugged lamination construction
- Polyimide, silicone rubber or Mylar™ insulation
- All models are RoHS compliant

Specifications

Body material: Silicone rubber with polyimide backing.

Temperature range:

RTD: -62 to 200°C (-80 to 392°F).

Thermistor: -45.5 to 135°C (-50 to 275°F).

Leadwires: AWG 24, silicone rubber.

Moisture resistance: Meets MIL-STD-202, Method 104, Test Condition B.

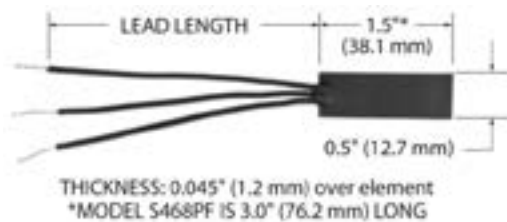

Model numbers

| Element | TCR | Outside air sensors |
|--|---------|---------------------------------------|
| RTDs | | |
| Platinum 100 Ω +/-0.1% at 0°C | 0.00391 | S464PB |
| Platinum 100 Ω +/-0.1% at 0°C (Meets EN60751, Class B) | 0.00385 | S467PD |
| Platinum 1000 Ω +/-0.1% at 0°C | 0.00385 | S468PF |
| Nickel-iron 1000 Ω +/-0.12% at 70°F | 0.00527 | S462FC |
| Nickel-iron 2000 Ω +/-0.12% at 70°F | 0.00527 | S463FC |
| HW 3000 Ω at -30.2°C | 0.00262 | S100001PX |
| Thermistors | | R₂₅/R₁₂₅ |
| Thermistor 2,252 Ω at +/-1% at 25°C | 29.2 | TS436TA |
| Thermistor 10,000 Ω at +/-1% at 25°C | 23.5 | TS437TB |





Specification and order options

| S467PD | Model number from table |
|--|---|
| Z | Number of leads: Y = 2 leads Z = 3 leads (RTD only) YS = 2 leads, stainless steel braid ZS = 3 leads, stainless steel braid (RTD only) |
| 36 | Lead length in inches: Specify in 0.1" increments (Ex: 60 = 6.0 inches) |
| A | Adhesive backing: A = No adhesive backing B = Pressure-sensitive adhesive |
| S467PDZ36A = Sample part number | |

Thermal-Tab and Thermal-Ribbon Sensors

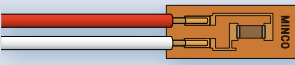
Surface sensing eliminates the need for a thermowell

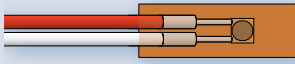
Thermal-Tab Specifications

| Dimensions W x L x T _{max} | Element options | Insulation | Temperature range | Leadwires | Time constant | Features | Model |
|--|--------------------|---|------------------------------|--|------------------|--|----------------|
|  0.20 x 0.50 x 0.08" (5 x 12 x 2 mm) | PD, PF | Polyimide with elastomer cover coat | -50 to 155°C -58 to 311°F | AWG 26, PTFE insulated | 0.8 sec | Stocked for immediate shipment | S665 |
|  0.20 x 0.60 x 0.08" (5 x 15 x 2 mm) | PD, PF, PW, PS | Polyimide | -50 to 200°C -58 to 392°F | AWG 26, PTFE or polyimide insulated | 1.0 sec | Platinum models in stock | S17624 |
|  0.20 x 0.60 x 0.08" (5 x 15 x 2 mm) | PD, PF | Polyimide fim | -50 to 260°C -58 to 500°F | AWG 26, PTFE or polyimide insulated | 0.4 sec | Highest temperature capability | S100820 |
|  0.20 x 0.60 x 0.12" (5 x 15 x 3 mm) | PD, PF | Silicone rubber with elastomer cover and foil backing | -50 to 155°C -58 to 311°F | AWG 24, silicone insulated | 1.3 sec | Waterproof; suitable for continuous immersion | S667 |
|  0.40 x 0.80 x 0.08" (10 x 20 x 2 mm) | PD, PF | Silicone rubber | -50 to 220°C -58 to 428°F | AWG 26, PTFE or polyimide insulated | 1.5 sec | High temperature rating, available with a wide range of element options | S100721 |

Sensing Elements

| Sensing Element Specifications | | Code |
|---|----------------------|------|
| Platinum (0.00385 TCR) <i>(EN60751, Class B)</i> | 100 Ω ±0.12% at 0°C | PD |
| Platinum (0.00385 TCR) | 1000 Ω ±0.12% at 0°C | PF |
| Platinum (0.00375 TCR) | 1000 Ω ±0.12% at 0°C | PW |
| Platinum (0.00385 TCR) | 10k Ω ±0.12% at 0°C | PS |

Specification and order options

| | |
|---|---|
| S17624 | Model number from table |
| PD | Sensing element from table |
| Z | Number of leads: Y = 2 leads Z = 3 leads (N/A on S25, S38) X = 4 leads (N/A on S25, S38, or S665/S667) |
| T | T if S17624, S100721, S100820; Leave blank if S665 or S667 |
| 12 | Lead length in inches: 12, 36, 120 are standard S665/S667 = 60" max |
| A | Adhesive backing: A = No adhesive backing B = Pressure-sensitive adhesive |
| Stop here for all models except S665 or S667. For models S665 and S667, add: | |
| C | Compliance: C = RoHS Compliance |
| S665PDZ12AC = Sample part number | |



Thermal-Tab & Thermal-Ribbon Alternatives

Thermistor and thermocouple alternatives to RTDs

Thermistor Thermal-Tab Sensors

Model TS665 and TS667 offer extremely sensitive NTC thermistors for applications with small temperature changes. Model TS667 also features waterproof construction, making it suitable for continuous immersion.

Specifications

| Dimensions W x L x T _{max} | Element options | Insulation | Temperature range | Leadwires | Time constant* | Features | Model |
|---|-----------------|---|------------------------------|----------------------------|----------------|---|-------|
|  0.20 x 0.50 x 0.08" (5 x 12 x 2 mm) | TF, TK | Polyimide with elastomer cover coat | -50 to 125°C -58 to 257°F | AWG 26, PTFE insulated | 0.8 sec | Small, low-cost | TS665 |
|  0.20 x 0.60 x 0.12" (5 x 15 x 3 mm) | | Silicone rubber with elastomer cover and foil backing | | AWG 24, Silicone insulated | 1.3 sec | Waterproof, suitable for continuous immersion | TS667 |

Sensing elements

| Sensing element specifications | Code |
|----------------------------------|------|
| NTC thermistor 50k Ω ±1% at 25°C | TF |
| NTC thermistor 10k Ω ±1% at 25°C | TK |

Specification and order options

| | |
|-----------------------------------|--|
| TS665 | Model number from table |
| TF | <u>Sensing element from table</u> |
| Y | <u>Number of leads:</u> Y = 2 leads |
| 40 | <u>Lead length in inches:</u> 40" (60" max) |
| A | <u>Adhesive backing:</u> A = No adhesive B = Pressure-sensitive adhesive (PSA) |
| C | <u>Compliance:</u> C: RoHS compliant |
| TS665TFY40AC = Sample part number | |

Thermocouple Thermal-Ribbon Sensors

TC40 is a patch-style thermocouple that adheres to all types of surfaces for quick and easy mounting.

Specification

| | |
|--|---|
| Dimensions W x L x T _{max} | 0.75 x 0.75 x 0.065" (19.1 x 19.1 x 1.7 mm) |
| Junction type | E, J, K, or T |
| Insulation | Polyimide |
| Temp. range | -200 to 200°C (-328 to 392°F) |
| Leadwires | AWG 24, solid PTFE insulated |
| Time constant | 0.6 sec. |
| Features | Surface mounting |
| Model | TC40 |

Specification and order options

| | |
|--------------------------------|---|
| TC40 | Model number |
| J | <u>Junction type:</u> E, J, K, or T |
| T | <u>Covering over leadwires:</u> T: PTFE only S: Stainless steel braid |
| 40 | <u>Lead length in inches:</u> 40 and 240 are standard |
| A | <u>Adhesive backing:</u> A = No adhesive B = Pressure-sensitive adhesive (PSA) |
| TC40JT40A = Sample part number | |

Thermal-Ribbon Installation Methods

Perfect for non-immersive pipe sensing

Installation methods

Thermal-Ribbon sensors lend themselves to a variety of installation methods. You should avoid repeated bending during the installation process, and Thermal-Ribbons should not flex in use unless they are specifically designed to do so. Take care to secure leadwires so they do not pull against sensor bodies. Leadwires should be routed along the sensed surface a short distance so that they do not sink heat away from the sensing element. Listed below are some standard installation methods.

- **Pressure sensitive adhesive:** PSA (option B in part number) is the simplest mounting method, but it is restricted to flat surfaces and temperatures below 177°C (350°F). PSA is usually factory applied to the mounting surface of the Thermal-Ribbon. To install, just remove the backing paper and press in place.
- **#20 stretch tape:** High temperature silicone rubber tape for mounting Thermal-Ribbons to pipes or other cylinders as shown above. It comes in 1" wide rolls, 6 or 36 feet long.
- **#6 RTV cement:** Room temperature vulcanizing cement for mounting silicone rubber Thermal-Ribbons to flat or curved surfaces. It is available in 3 oz. (89 ml) tubes. Contact Minco for other adhesives usable with Kapton™ or Mylar™ Thermal-Ribbons.
- **Shrink bands:** Minco shrink bands are pre-stretched plastic strips with adhesive at both ends. Use them to mount Thermal-Ribbons to cylinders. Simply wrap the band around the sensor and cylinder, secure the ends, and heat to shrink in place. To order, specify band width and cylinder diameter.
- **#21 Polyimide tape:** High temperature tape with silicone-based adhesive. Useful for quick mounting of Thermal-Ribbon or Thermal-Tab sensors to flat surfaces. Makes a strong but removable bond to most smooth and clean surfaces. Maximum operating temperature is 150°C. 0.5 inch wide x 108 ft. long roll.

For further information on how to use these sensors, reference our white paper "Sensing Fluid Temperature with Thermal-Ribbons", available on Minco.com.

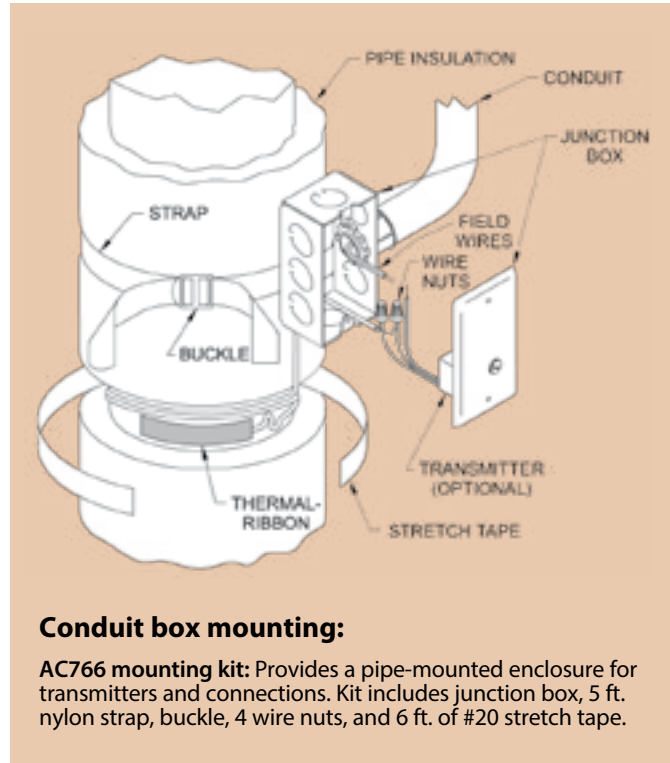





Conduit box mounting:

AC766 mounting kit: Provides a pipe-mounted enclosure for transmitters and connections. Kit includes junction box, 5 ft. nylon strap, buckle, 4 wire nuts, and 6 ft. of #20 stretch tape.

Bolt-On Temperature Sensors

Easy installation in industrial and commercial environments

| | Dimensions W x L x T (max.) | Temp. range | Element options | Case material | Leadwire | Model |
|---|--|-----------------------------|-----------------|----------------------|--|---------|
|  | 0.50 x 1.00 x 0.188" (12.7 x 25.4 x 4.8 mm) w/ 0.161" (4.1 mm) diameter hole | -70 to 500°C (-94 to 932°F) | PD, PF | Stainless steel | AWG 22, Mica-glass insulated | S101730 |
|  | 0.29 x 1.25 x 0.188" (7.4 x 31.8 x 4.8 mm) with 0.161" (4.1 mm) hole | -70 to 500°C (-94 to 932°F) | PD, PF | Stainless steel | AWG 22, Mica-glass insulated | S101731 |
|  | 0.265" (6.7 mm) ID ring lug | -50 to 260°C (-58 to 500°F) | PD, PF | Nickel plated copper | 2-lead: AWG 24, 3-lead: AWG 26, PTFE insulated | S101732 |
|  | 0.50 x 0.375 x 0.188" (12.7 x 9.5 x 4.8 mm) with 0.166" (4.2 mm) hole | -50 to 260°C (-58 to 500°F) | PD, PF | Stainless steel | 2 lead: AWG 24, 3 lead: AWG 26, PTFE insulated with SS braid cover | S101733 |
|  | 1/4 - 20 x 3/8" long thread with 7/16" hex head M6 x 1 thread, 10 mm long, with 10 mm hex | -50 to 260°C (-58 to 500°F) | PD, PF | Stainless steel | | S101734 |
| | | | | | | S101797 |

Overview

Bolt-on temperature sensors are designed for easy installation in industrial and commercial environments. The sensors can be mounted on machines, against process pipes, or embedded directly into a machined part. Threaded fasteners install in seconds and can be easily removed for installation at another location.

These sensors are ideal for process control measurements, test and verification of existing systems, and retrofitting existing machines. Standard designs allow prototyping without high setup costs, while significant discounts are available for large quantities.

Standard platinum RTD elements provide stable and reliable output compatible with most control and monitoring systems. Physically interchangeable designs allow you to easily customize your installation to different instrumentation. Minco can also provide custom RTD, thermistor or thermocouple elements in these packages, or specialized case designs to meet your application needs.

- Removable and reusable
- Wide temperature range
- Configurations to fit most applications
- Standard 100 Ω platinum and 1000 Ω platinum elements

Specifications

Time constant: Less than 10 seconds in moving water.

Insulation resistance: 10 megohms minimum at 100 VDC, leads to case.

Vibration: Withstands 10 to 2000 Hz at 20 G's minimum per MIL-STD-202. Method 204, test condition D.







Specification and order options

| S101732 | Model number from table |
|------------------------------------|--|
| PD | Element code from table |
| 3 | Number of leads: 2 or 3 2 leads not recommended for PD models |
| S | Leadwire covering: G = Mica-glass (S101730 and S101731) T = PTFE (S101732, S101733, S101734, and S101797) S = Stainless steel braid over PTFE insulated leads (S101732, S101733, S101734, and S101797) |
| 40 | Leadwire length in inches: 40" (1000mm) standard: 40,120 |
| S101732PD3S40 = Sample part number | |

| RTD Sensing Element | Code |
|--|------|
| Platinum (0.00385 TCR) 100 Ω ±0.12% at 0°C (Meets EN60751, Class B) | PD |
| Platinum (0.00385 TCR) 1000 Ω ±0.1% at 0°C | PF |

Economy Sensors

Pre-attached leads make these sensors ready to install

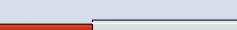
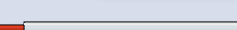
| | Dimensions W x L x T (max.) | Temperature range | Element options | Case material | Leadwire | Model |
|---|--|---------------------------------|--------------------|--------------------|---|----------------|
|  | 2 leads: .050" x .065" x .040" thick (1.3 x 1.7 x 1.0 mm) Thin-Film with insulated leads | -50 to 150°C (-58 to 302°F) | PD, PF | Ceramic | AWG 32, solid enamel insulated | S102404 |
|  | 3 leads: .063" x .098" x .052" thick (1.6 x 2.5 x 1.3 mm) Thin-Film with insulated leads | | | | | |
|  | Ø .125" x .90" (Ø 3.2 x 22.9 mm) | -50 to 260°C (-58 to 500°F) | PD, PF | Stainless steel | AWG 26, PTFE insulated | S102409 |
|  | Ø .125" x .90" (Ø 3.2 x 22.9 mm) | -50 to 155°C (-58 to 311°F) | PD, PF | Stainless steel | AWG 30, PTFE insulated | S102737 |
|  | Ø .140" x .40" (Ø 3.6 x 10.2 mm) | -70 to 500°C (-94 to 932°F) | PD, PF | Ceramic | AWG 27, solid glass insulated nickel | S102410 |
|  | Ø .188" x .90" (Ø 4.8 x 22.9 mm) | -50 to 150°C (-58 to 302°F) | PD, PF | Silicone rubber | AWG 24, silicone rubber insulated | S102406 |
|  | Ø .188" x 1.25" (Ø 4.8 x 31.8 mm) | -50 to 230°C (-58 to 446°F) | PD, PF | PTFE | AWG 24, PTFE with PTFE jacket | S102405 |
|  | Ø .188" x 1.25" (Ø 4.8 x 31.8 mm) | -50 to 260°C (-58 to 500°F) | PD, PF | Aluminum | AWG 22, PTFE insulated | S102407 |
|  | Ø .188" x 2.38" (Ø 4.8 x 60.5 mm) | -70 to 550°C (-94 to 1022°F) | PD, PF | Stainless steel | AWG 22, glass braid insulated | S102408 |

Overview

Economy sensors are designed to be a component of your final assembly. With insulated leads preattached and strain relieved, final construction is easy and reliable.

- Insulated leads of variable length, installed and strain relieved
- Wide temperature range
- Configurations to fit most applications
- Standard 100 Ω platinum and 1000 Ω platinum elements

Specifications

Insulation resistance: 10 megohms minimum at 100 VDC, leads to case.

Vibration: Withstands 10 to 2000 Hz at 20 G's minimum per MIL-STD-202. Method 204, test condition D.

| RTD Sensing Element | Code |
|--|------|
| Platinum (0.00385 TCR) 100 Ω ±0.1% at 0°C <i>(Meets EN60751, Class B)</i> | PD |
| Platinum (0.00385 TCR) 1000 Ω ±0.1% at 0°C | PF |

Specification and order options

| S102408 | Model number from table |
|---|---|
| PD | Element code from table |
| 3 | Number of leads: 2 leads (not recommended for PD models) 3 leads (only option for S102410PD) |
| G | Leadwire covering: E = Enamel (S102404) G = Mica-glass (S102408 and S102410) R = Silicone rubber (S102406) T = PTFE (S102405, S102407, S102409, S102737) |
| 40 | Lead length in inches: Standard: 40, 120 |
| S102408PD3G40 = Sample part number | |

Fluid Immersion Temperature Sensors

Measure fluid streams

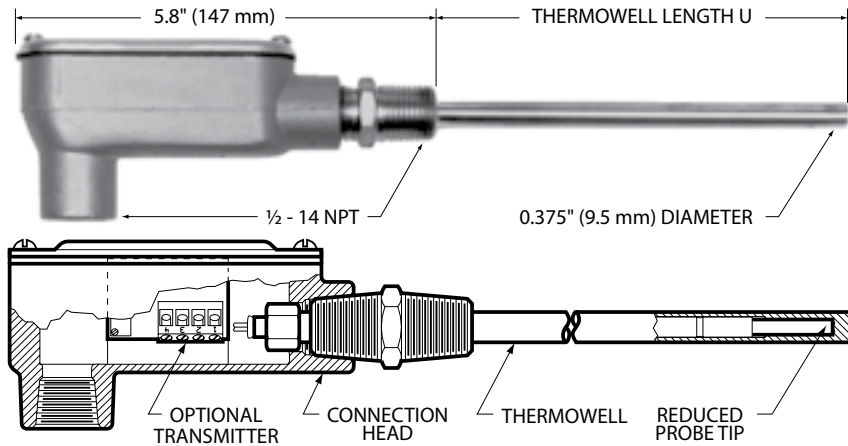

Fluid immersion sensors

| | |
|--------------------------------|--|
| S479PD | Model number from table |
| Y | Number of leadwires: Y = 2 leads Z = 3 leads |
| 60 | Thermowell length U: Specify in 0.1" increments (Ex: 60 = 60 inches) 20, 30, 60 Contact Minco for other lengths |
| S479PDY60 = Sample part number | |

Overview

Immersion sensors include stainless steel thermowells for insertion directly into fluid streams. The sensing probe may be removed without breaking the fluid seal. Brass thermowells are also available.

Specifications

- Temperature range:** -45.5 to 260°C (-50 to 500°F).
- Leadwires:** AWG 22, PTFE insulated, 4" (100 mm) long.
- Thermowell pressure rating:** 1880 psi (130 bar).
- Moisture resistance:** Meets MIL-STD-202, Method 104, Test Condition B.

Note: These sensors are intended for use in slow-moving fluid streams. For applications where fluid velocity exceeds 3 ft/s, you may need to use a thermowell assembly as an alternative. Contact Minco Sales and Customer Service for additional information.

Model numbers

| | Element | TCR Ω/Ω/°C | Model number |
|-------------|---|------------|--------------|
| Platinum | 100 Ω ±0.1% at 0°C | 0.00391 | S478PB |
| Platinum | 100 Ω ±0.12% at 0°C (Meets EN60751, Class B) | 0.00385 | S479PD |
| Platinum | 1000 Ω ±0.12% at 0°C | 0.00385 | S480PF |
| Platinum | 1000 Ω ±0.12% at 0°C | 0.00375 | S490PW* |
| Nickel-iron | 1000 Ω ±0.12% at 70°F | 0.00527 | S476FB* |
| Nickel-iron | 2000 Ω ±0.12% at 70°F | 0.00527 | S477FC* |
| HW | 3000 Ω at -30.2°C | 0.00262 | S100061PX* |

* Maximum temperature is 135°C/275°F

Replacement stainless steel thermowells

| | |
|-------------------------------|---|
| TW488 | Model number |
| U | |
| 60 | Thermowell length U: Specify in 0.1" increments (Ex: 60 = 60 inches) Standard thermowell lengths are 3" and 6"; contact Minco for other lengths |
| TW488U60 = Sample part number | |

To order with transmitter, add

| | |
|---------------------------------------|--|
| TT111 | Transmitter Models: TT111: Fixed Range (2 leads) TT211: Fixed Range (2 leads) TT321: Fixed Range (3 leads) <i>Other transmitter options available.</i> |
| A | Temperature Range Code: A = 20°F to 120°F (-6.7°C to 48.9°C) <i>See pages 42-43 or contact Minco for a complete list of available temperature codes.</i> |
| 1 | Calibration: 1 = Nominal Calibration 2 = Match Calibrated, 0.75% Total System Accuracy 3 = Match Calibrated, 0.5% Total System Accuracy 4 = Match Calibrated, 0.2% or 1C Total System Accuracy |
| TT111A1 = Sample part number addition | |

Fast-Response RTDs

Measure temperature in high-pressure and corrosive fluids

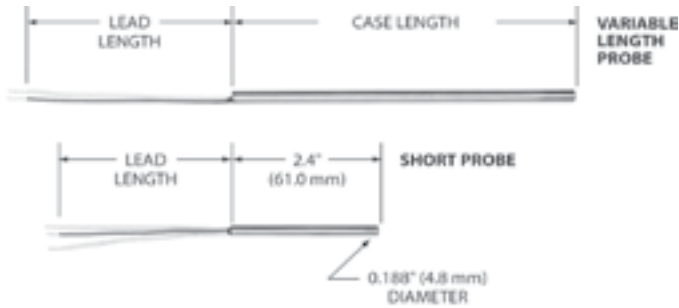

Overview

These probes have rugged stainless steel cases for use in high pressures or corrosive fluids. Yet their time constants are comparable to copper-tipped probes at 2 to 4 seconds, compared to 8 to 10 seconds for other all-stainless probes.

- Unique low-mass element reacts quickly to temperature changes
- Non-armor models can be user-shortened. *Not applicable to short probes.*

Specifications

Temperature range: -269 to 260°C (-452 to 500°F).

Case material:

- S601, S603, S604: 316 stainless steel.
- S602, S614: 304/305 stainless steel.

Case length:

Minimum case length:

- S602, S604: 2.0" (50.8 mm) with PTFE insulated leads; 3.0" (76.2 mm) with SS braid over leads.
- S601, S603: 3.0" (76.2 mm).

Maximum case length:

- 48" (1220 mm), longer on special order.

Time constant:

Typical in moving water:

- S602, S604, S614: 2 seconds.
- S601: 3 seconds.
- S603: 4 seconds.

Pressure rating: 1500 psi (103 bar).

Leads: 2, 3, or 4 leadwires, AWG 22, stranded copper with PTFE insulation, stainless steel braid, or stainless steel armor. S602 has AWG 26 leads.

For 2-lead RTDs add 0.03 Ω per foot of combined case and lead length to element tolerance (0.08 Ω per foot for S602).

Insulation resistance: 1000 megohms minimum at 500 VDC, leads to case.

Vibration: Withstands 10 to 2000 Hz at 20 G's minimum per MIL-STD-202, Method 204, Test Condition D.

Shock: Withstands 100 G's minimum sine wave shock of 8 milliseconds duration.

| RTD Sensing Element | Code |
|--|------|
| Platinum (0.00392 TCR) 100 Ω ±0.5% at 0°C | PA |
| Platinum (0.00385 TCR) 100 Ω ±0.12% at 0°C (Meets EN60751, Class B) | PD |
| Platinum (0.00385 TCR) 100 Ω ±0.5% at 0°C | PE |
| Platinum (0.00385 TCR) 1000 Ω ±0.12% at 0°C (N/A for model S602) | PF |
| Nickel (0.00672 TCR) S601, S603 120 Ω ±0.5% at 0°C | NA |

Fast Resonse Probes

Specify 0.125" or 0.188" for fastest response, 0.250" or 0.215" for greater strength and cut-to-length capability (PTFE and SS braid models).

| | |
|---|--|
| S604 | Model number: S601: Ø 0.215" (5.5mm) cut-to-length probe S602: Ø 0.125" (3.2mm) S603: Ø 0.250" (6.4mm) cut-to-length probe S604: Ø 0.188" (4.8mm) |
| PD | Sensing element from table: PA, PD, PE, PF, NA |
| 240 | Case length: Specify in 0.1" increments (e.g., 240 = 24.0") |
| X | Number of leadwires: Y = 2 leads Z = 3 leads (required for copper elements) X = 4 leads (PD only) |
| 36 | Lead length in inches: 36, 120 are standard |
| T | Covering over leadwires: T = PTFE only S = Stainless steel braid A = Stainless steel armor (S, A not available on S602) |
| S604PD240X36T = Sample part number | |

Short Probes

| | |
|--|---|
| S614 | Model number (case with fixed length of 2.4" / 61 mm) |
| PA | Sensing element from table: PA, PD, PF |
| Z | Number of leadwires: Y = 2 leads Z = 3 leads (required for copper elements) X = 4 leads (PD only) |
| 36 | Lead length in inches: 36 |
| T | Covering over leadwires: T = PTFE only S = Stainless steel braid |
| S614PAZ36T = Sample part number | |

Fast-Response Immersion RTDs

Mount directly in fluid streams for accurate, reliable sensing

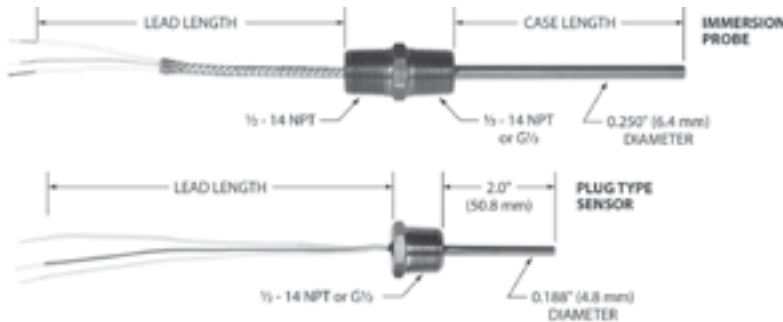

Overview

You can mount these probes directly in fluid streams for accurate, reliable sensing. Time constant is just 2 seconds, compared to 10 seconds for an ordinary stainless probe or up to 50 seconds for a thermowell. The result is more accurate monitoring of dynamic processes.

- Pressure rating 1500 psi (103 bar)
- Quick reaction to changing fluid and gas temperatures
- NPT (U.S.) or metric threads

Specifications

Temperature range: -269 to 260°C (-452 to 500°F).

Case material:

- S623, S628: 316 stainless steel.
- S634, S639: 304/305 stainless steel.

Case length:

- Minimum case length: 1.5" (38.1 mm).
- Maximum case length: 48" (1220 mm), longer on special order.

Time constant: Typical value in moving water:

- S623, S628: 4 seconds.
- S634, S639: 2 seconds.

Pressure rating: 1500 psi (103 bar).

Leads: 2, 3, or 4 leadwires, AWG 22, stranded copper with PTFE insulation, stainless steel braid, or stainless steel armor.

For 2-lead RTDs add 0.03 Ω per foot of combined case and lead length to element tolerance.

Insulation resistance: 1000 megohms minimum at 500 VDC, leads to case.

Vibration: Withstands 10 to 2000 Hz at 20 G's minimum per MIL-STD-202, Method 204, Test Condition D.

Shock: Withstands 100 G's minimum sine wave shock of 8 milliseconds duration.

| RTD Sensing Element | Code |
|--|------|
| Platinum (0.00392 TCR) 100 Ω ±0.5% at 0°C | PA |
| Platinum (0.00385 TCR) 100 Ω ±0.12% at 0°C (Meets EN60751, Class B) | PD |
| Platinum (0.00385 TCR) 1000 Ω ±0.10% at 0°C | PF |

Immersion Probes

These probes have welded fittings to mount directly into fluid vessels. Add a connection head for termination of extension leads.

| | |
|--|---|
| S623 | Model number: S623: 1/2-14 NPT thread [2] S628: ISO 228/1-G1/2 process thread (1/2-14 NPT on lead's end) |
| PF | Sensing element from table: PA, PD, PF |
| 60 | Case length: Specify in 0.1" increments (e.g., 60 = 6.0") 20, 60, 120 are standard |
| Z | Number of leadwires: Y = 2 leads Z = 3 leads (required for copper elements) X = 4 leads (PD only) |
| 72 | Lead length in inches: 72 |
| T | Covering over leadwires: T = PTFE only S = Stainless steel braid A = Stainless steel armor |
| S623PF60Z72T = Sample part number | |

Plug-type sensors

| | |
|--|--|
| S634 | Model number: S634: 1/2-14 NPT thread S639: ISO 228/1-G1/2 thread |
| PD | Sensing element from table: PA, PD, PF |
| Z | Number of leadwires: Y = 2 leads Z = 3 leads X = 4 leads (PD only) |
| 36 | Lead length in inches: 36 is standard |
| T | Covering over leadwires: T = PTFE only S = Stainless steel braid |
| S634PDZ36T = Sample part number | |

Compact Plug Sensor

Convenient plug-in temperature sensor

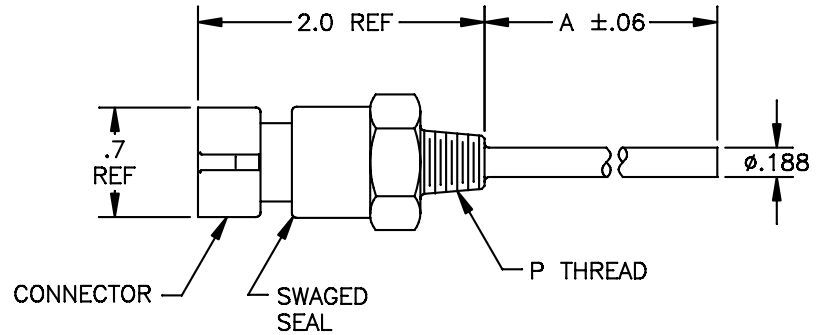

Overview

The S205459 is a platinum RTD temperature sensor with convenient plug in connection.

- Sensor measuring and operating range is from -50 to 300°F (-45.5 to 148.9°C).
- Connection is made using an industry-standard Packard/Delphi: Metri-pack 150 connector

Specifications

Temp Range: -50 to 300°F (-45.5 to 148.9°C)

Case Material: 316 Stainless Steel

Connector: Packard /Delphi METRI-PACK 150

Pressure Rating:

Stainless Steel: 1500 psi

Insulation Resistance: 1000 megaohms min at 500 V

Vibration: Withstands 10 to 2000 Hz at 20 G's min per MIL-STD-202, Method 204 Test Condition D

Shock: Withstands 100 Gs min sine wave shock of 8 milliseconds duration.

Sensor Housing: Stainless steel sensor end with a choice of NPT threads; end connector (Packard/Delphi: Metri-pack 150).

Specifications and order options

| | |
|-------------------------------------|---|
| S205459 | Model number: S205459 Compact Plug Sensor |
| PD | Element Type: PD Platinum (0.00385 TCR) 100 Ω +/- 0.12% at 0°C PF Platinum (0.00385 TCR) 1000 Ω +/- 0.12% at 0°C |
| 20 | Case Length: 10 = 1.0" 20 = 2.0" 30 = 3.0" 40 = 4.0" |
| P2 | Thread size: P2 = 1/8 -27 NPT P4 = 1/4 -18 NPT P6 = 3/8 -18 NPT P8 = 1/2 -14 NPT |
| S | Case Material: S = Stainless Steel |
| S205459PD20P2S = Sample part number | |

S205459 Mating Cable Assembly

- 72" Shielded cable
- 2-conductor, AWG #18, copper braid shield with drain wire
- Terminated with a female Metri-pack 150 connector

S205459 Mating Cable Assembly

| | |
|----------------------------------|-------------------------------|
| AC203350 | Model number: AC203350 |
| L72 | 72" lead length |
| AC203350L72 = Sample part number | |

Integrated Sensor/Transmitter

Platinum RTD Combined with a 4-20mA Transmitter

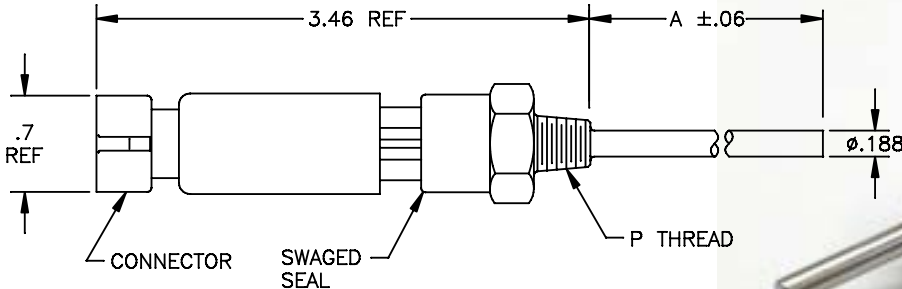

Overview

The TT363 is an integrated platinum RTD temperature sensor with 4-20mA current loop output. Combines transmitter capability with a platinum sensing element in a single package for an easier-to-install temperature sensing solution.

- Power and signal are provided through a 4-20mA current loop connection.
- Sensor measuring and operating range is from -50 to 300°F (-45.5 to 148.9°C).
- The high-temperature plastic case and electronics can be used in applications with an ambient temperature up to 185°F (85°C).
- Connection is made using an industry-standard Packard/Delphi: Metri-pack 150 connector.

Specifications

Output: 4-20mA over range specified, linear with temperature.

Sensor operating temperature: -50 to 300°F (-45.5 to 148.9°C)

Ambient temperature:

Operation: -40 to 185°F (-40 to 85°C), non-condensing
Storage: -67 to 212°F (-55 to 100°C), non-condensing

Supply voltage: 7.6 to 35VDC, reverse polarity protected

Loop resistance: Maximum allowable resistance of the signal-carrying loop, including wires and load resistors given by:
 $R_{loopmax} = (V_{supply} - 7.6) / .02Amps$

Warmup drift: Less than +/-0.025mA; stable within 30 minutes.

Ambient temperature error: Less than +/-0.15mA

Voltage stability: Change in loop current < ±0.01 mA from 7.6 to 35 VDC

Sensor housing: Stainless steel sensor case with a choice of NPT threads; transmitter body is nylon with 30% glass plastic encapsulation; end connector (Packard/Delphi: Metri-pack 150)

Specifications and order options

| | |
|-----------------------------------|--|
| TT363 | Model number: TT363 Temperature Sensor/Transmitter |
| AN | Range Code: Temperature range code (AN = -178 to 148.9°C (0 to 300°F) <i>See pages 42-43 for additional range codes.</i> |
| 20 | Case Length: 10 = 1.0", 20 = 2.0", 30 = 3.0", 40 = 4.0" |
| P2 | Thread size: P2 = 1/8 -27 NPT P4 = 1/4 -18 NPT P6 = 3/8 -18 NPT P8 = 1/2 -14 NPT |
| S | Case Material: S = Stainless Steel |
| TT363AN20P2S = Sample part number | |

TT363 Mating Cable Assembly

- 72" Shielded cable
- 2-conductor, AWG #18, copper braid shield with drain wire
- Terminated with a female Metri-pack 150 connector

TT363 Mating Cable Assembly

| | |
|----------------------------------|----------------------------|
| AC203350 | Model number: TT363 |
| L72 | 72" lead length |
| AC203350L72 = Sample part number | |

Instruments

| | |
|---|----|
| Miniature DC Temperature Controller | 37 |
| Loop-Powered Indicator | 39 |
| Temptran 4 to 20 mA RTD Transmitter..... | 40 |
| Temptran Temperature Ranges | 42 |
| Programmable Temperature Transmitters | 44 |

CT325 Miniature DC Temperature Controller

Inexpensive on/off temperature control

Overview

The CT325 Miniature DC Temperature Controller is designed for use with Minco Thermofoil™ heaters and RTD or thermistor sensors. It offers inexpensive on/off temperature control of your process or equipment with accuracy many times better than bimetal thermostats. Easily read and adjust the set point temperature using a voltmeter, then monitor the actual signal temperature at the other end. Operating from your 4.75 to 60 volt DC power supply, the controller can switch up to 4 amps power to the heater. A bright LED indicates when power is applied to the heater.

- The entire unit is epoxy filled for moisture resistance, with a through-hole for a mounting bolt. A terminal block provides the power input, sensor input and heater output connections.
- Tight control in a small package means that enclosures or panel spaces are not required which allows successful portable device implementation
- Simple control without complicated programming can reduce set-up time
- Three-wire RTD connection cancels lead resistance for highly accurate temperature readings
- Solid state on-off control with adjustable set point improves durability compared to electro-mechanical devices
- Flexible heating control compliments all Minco Thermofoil heaters for convenient off the shelf operation
- Uses standard 100 Ω or 1000 Ω platinum RTD or 50k Ω thermistor sensor input
- Single DC power source provides power to the controller and heater up to 240 watts

Applications

- IV solutions for medical/surgical applications
- Military batteries
- Enclosures to maintain the temperature of electronics
- Ruggedized laptop LCDs and harddrives

Custom design options

Minco can customize the design of the CT325 for special applications. Specific temperature ranges, other sensor options, and special packaging are possible for volume OEM applications.



Specifications

- Input: 100 Ω or 1000 Ω platinum RTD, 0.00385 $\Omega/^\circ\text{C}$, 2 or 3-leads, or 50k Ω NTC thermistor, 2-lead.
- Setpoint range: 2 to 200 $^\circ\text{C}$ (36 to 392 $^\circ\text{F}$) for platinum RTD input. 25 to 75 $^\circ\text{C}$ (77 to 167 $^\circ\text{F}$) for thermistor input. Consult factory for other ranges.
- Setpoint stability: $\pm 0.02\%$ of span/ $^\circ\text{C}$.
- Vtemp signal: 0.010 V/ $^\circ\text{C}$ over specified range.
- Deadband: $\pm 0.1^\circ\text{C}$ (0.2 $^\circ\text{F}$).
- Input power: 4.75 to 60 VDC.
- Output: Open drain, 4 amps max. DC.
- Leadwire compensation: (3-wire RTD) $\pm 0.06^\circ\text{C}/\Omega$ for 100 Ω or 1000 Ω platinum up to 25 Ω per leg.
- Fault protection: Heater disabled on RTD short or thermistor open. No heater protection; external fuse is recommended.
- Operating ambient temperature range: -40 to 70 $^\circ\text{C}$ (-40 to 158 $^\circ\text{F}$).
- Relative humidity: 0 to 95% non-condensing.
- Physical: Polycarbonate case, epoxy sealed for moisture resistance.
- Weight: 1 oz. (28g).
- Connections: Terminal block for wires AWG 22 to AWG 14.
- Mounting: Mounting hole for #6 screw through or #8 thread forming screw.

CT325 Miniature DC Temperature Controller

Specifications and order options

Specification and order options

| | |
|---------------------------------|--|
| CT325 | Model number |
| PD | Sensor type from table below |
| 1 | Power supply: 1 = 4.75 to 10 VDC 2 = 7.5 to 60 VDC |
| C | Temperature range: A = 25 to 75°C (thermistor only) C = 2 to 200°C (RTD only) |
| 1 | Dead band: 1 = 0.1°C |
| CT325PD1C1 = Sample part number | |

| Sensor type | Code |
|---------------------|------|
| 100 Ω platinum RTD | PD |
| 1000 Ω platinum RTD | PF |
| 50k Ω thermistor | TF |

Dimensions in inches

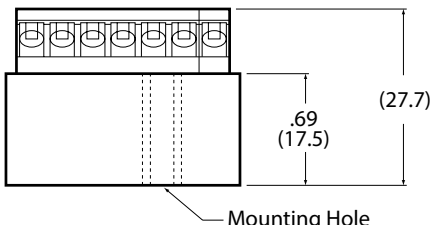
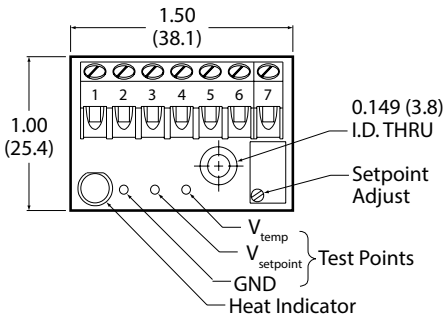

Wiring diagrams

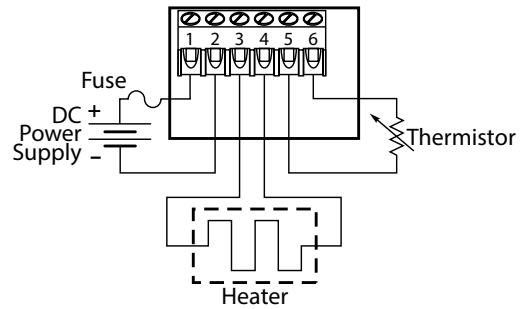
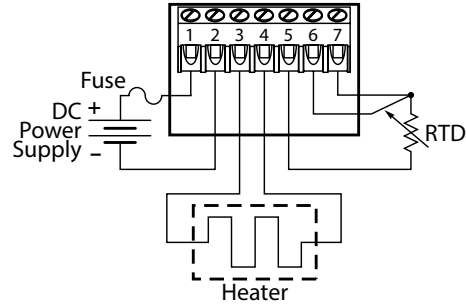

AC powered heaters

The CT325 can provide the control signal to an external solid state relay to switch AC power. Use 15 VDC as the control voltage.

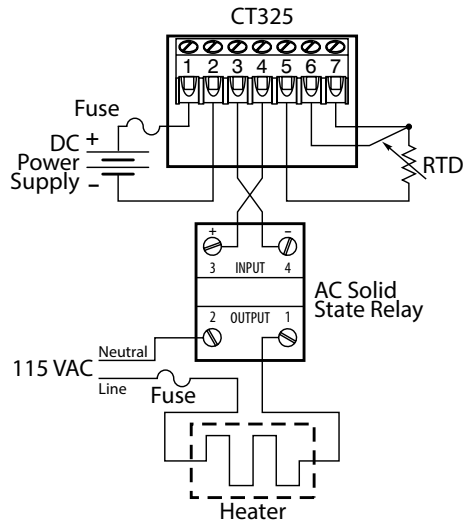

TI350 Loop-Powered Indicator

Easily display temperature

Overview

The TI350 features a washdown compatible digital readout for local indication of temperature. Sensors and transmitters are specified separately. Optional Temptran model TT321 will fit inside the case along with the meter. Other 4 to 20 mA transmitters may be mounted outside the case and used with this device.

The display range is field programmable via coarse dip switches and two fine adjustment potentiometers. Wiring is easy. Simply connect the indicator in series with the 4 to 20 mA loop. Forward voltage drop is only 2.8 VDC.

- Local indication of process variable for convenient visual verification
- Enclosures are sealed from harsh environments to enhance product reliability and longevity
- Variety of mounting options allows for flexible and easy installation
- Compatible with 4 to 20 mA temperature transmitters for easy sensor interchangeability
- NEMA 4X enclosure
- Cable glands are installed for 0.118" to 0.256" (3mm to 6.5mm) cable

AC102765 pipe mounting hardware kit

Use AC102765 for mounting TI350 to vertical or horizontal pipe. Kit includes plate, stainless U-bolts, nuts and washers for 2" schedule 40 pipe [Ø 2.375" (60mm)].

Order model number AC102765



Miniature Temptran™ RTD Transmitters

4 to 20 mA over specified range, linear with temperature



TT111 only



Overview

- Two models:
TT111: UL-recognized component for Canada and United States.
TT211: Wider ambient rating; no agency approvals
- Optional high-accuracy calibration to Minco RTDs for improved accuracy; see sensor ordering information for options information

Specifications

Output: 4 to 20 mA over specified range, linear with temperature.

Calibration accuracy: ±0.1% of span.

Linearity: Referenced to actual sensor temperature. Platinum RTD input: ±0.1% of span.
Nickel and nickel-iron RTD input:

- ±0.25% of span for spans less than 100°C.
- ±0.25% of span per 100°C of span for spans greater than 100°C.

Adjustments: Zero and span, ±5% of span. Factory set.

Ambient temperature:

- TT111 and TT321: 0 to 50°C (32 to 122°F).
- TT211: -25 to 85°C (-13 to 185°F).
- Storage: -55 to 100°C (-67 to 212°F).

Ambient temperature effects:

- ±0.013% of span per °C.
- ±0.025% of span per °C for spans less than 55°C.

Warmup drift: ±0.1% of span max., with
 $V_{supply} = 24$ VDC and $R_{loop} = 250$ W.
Stable within 30 minutes.

Supply voltage: 8.5 to 35 VDC. Voltage effect ±0.001% of span per volt. Reverse polarity protected.

Maximum load resistance: The maximum allowable resistance of the signal carrying loop is:

$$R_{loop\ max} = \frac{V_{supply} - 8.5}{0.020\ \text{amps}}$$

Example: With supply voltage 24 VDC, maximum loop resistance is 775 Ω.

Minimum span: 27.8°C (50°F).

Connections:

Terminal block for wires AWG 22 to AWG 14.

Physical: Polycarbonate case, epoxy potted for moisture resistance.

Weight: 1.1 oz. (30 g).

Miniature Temptran RTD Transmitters

Specifications and order options

RTD input types

2-wire resistance thermometer:

| Sensing Element Specifications | | Code |
|--------------------------------|----------------|--------|
| Platinum (0.00392 TCR) | 100 Ω at 0°C | PA |
| Platinum (0.00391 TCR) | 100 Ω at 0°C | PB |
| Platinum (0.00385 TCR) | 100 Ω at 0°C | PD, PE |
| Platinum (0.00385 TCR) | 1000 Ω at 0°C | PF |
| Platinum (0.00375 TCR) | 1000 Ω 0°C | PW |
| Nickel-iron (0.00518 TCR) | 604 Ω at 0°C | FA |
| Nickel-iron (0.00527 TCR) | 1000 Ω at 70°F | FB |
| Nickel-iron (0.00527 TCR) | 2000 Ω at 70°F | FC |
| Nickel (0.00672 TCR) | 120 Ω at 0°C | NA |

Special high-accuracy calibration

For high system accuracy, specify transmitters with matched calibration. Temptrans match-calibrated to a sensor are always ordered as assemblies. Common examples are found on pages 40-44.

Specification and order options

| TT111 | Model number: TT111 or TT211 |
|--------------------------------|---|
| PD | RTD element code from table |
| 1 | Output 4 to 20mA DC |
| C | Temperature range code starting on pages 42-43. <i>Example: C = 0 to 100°C (32 to 212°F)</i> |
| TT111PD1C = Sample part number | |

Dimensions in inches (mm)

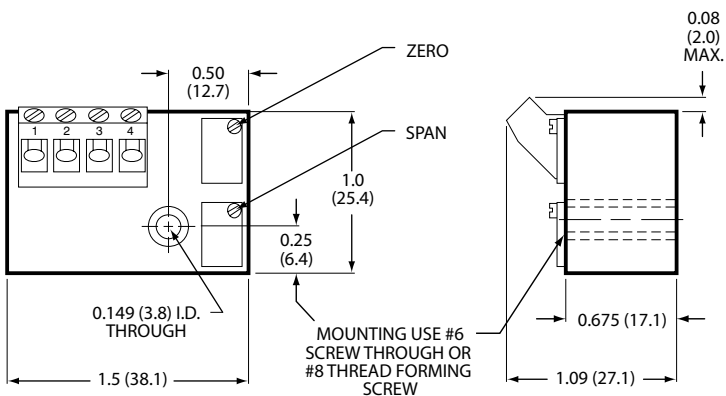

TT111 TT211

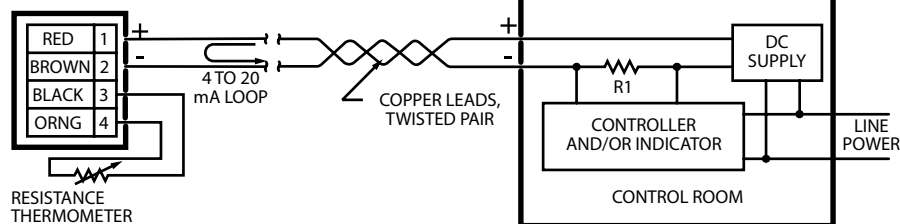

Temptran Temperature Ranges

Select the range code that matches your application

Below is a list of commonly selected Temptran temperature ranges. The endpoints of the temperature range correspond to the Temptran's 4 and 20 mA signals. Choose the smallest possible span for best accuracy. Be sure to check the temperature limits of the sensor you specify. If you do not find the temperature range required by your application, go to www.minco.com for a complete list of temperature ranges. Custom ranges are also available for a small setup charge. Contact Minco Sales and Customer Service for more information.

| Range code | | | | | RTD Temptrans | | |
|------------|-------------------|---------|---------|---------|----------------------|----------------|-------------------|
| | Temperature Range | | | | TT111, TT115, TT211 | | TT321 |
| | Zero °F | Span °F | Zero °C | Span °C | Platinum elements | Other elements | Platinum elements |
| MH | -328 | -148 | -200 | -100 | PA PB PD PE | | PA PB PD PE |
| HG | -325 | 100 | -198.3 | 37.8 | PA PB PD PE PF PW | | |
| QS | -300 | 150 | -184.4 | 65.6 | PA PB PD PE | | |
| EZ | -148 | 32 | -100 | 0 | PA PB PD PE PF PW | | PA PB PD PE |
| LN | -148 | 212 | -100 | 100 | PA PB PD PE | | |
| SA | -140 | 100 | -95.6 | 37.8 | | | |
| UL | -103 | 752 | -75 | 400 | | | |
| M | -58 | 122 | -50 | 50 | PA PB PD PE PF PW | | PA PB PD PE |
| EO | -58 | 212 | -50 | 100 | PA PB PD PE | NA | |
| JD | -58 | 302 | -50 | 150 | PA PB PD PE | | |
| MR | -58 | 500 | -50 | 260 | PA PB PD PE | | |
| SD | -50 | 100 | -45.6 | 37.8 | PA PB PD PE | | |
| MI | -50 | 150 | -45.6 | 65.6 | PA PB PD PE | | |
| AI | -50 | 275 | -45.6 | 135 | PA PB PD PE PW | FB FC NA | |
| MS | -50 | 650 | -45.6 | 343.3 | PA PB PD PE | | |
| AD | -40 | 120 | -40 | 48.9 | PA PB PD PE | FB FC | PA PB PD PE |
| AK | -40 | 140 | -40 | 60 | PA PB PD PE PU | | PA PB PD PE |
| BE | -40 | 160 | -40 | 71 | PA PB PD PE | FB | |
| GH | -40 | 212 | -40 | 100 | PA PB PD PE | | |
| UE | -40 | 302 | -40 | 150 | PA PB PD PE | | |
| L | -30 | 120 | -34.4 | 48.9 | PA PB PD PE PF PW | FB FC | |
| AS | -30 | 130 | -34.4 | 54.4 | PA PB PD PE PF PW | FB | PA PB PD PE |
| R | -30 | 150 | -34.4 | 65.5 | PA PB PD PE | FB FC | |
| DN | -22 | 122 | -30 | 50 | PA PB PD PE | | PA PB PD PE |
| EE | -22 | 302 | -30 | 150 | PA PB PD PE | | |
| DO | -20 | 120 | -28.9 | 48.9 | PA PB PD PE PF PW | ND | |
| EN | -20 | 140 | -28.9 | 60 | PA PB PD PE PF PW | FB | |
| B | -20 | 180 | -28.9 | 82.2 | PA PB PD PE | FB FC NA | |
| BP | -4 | 104 | -20 | 40 | PA PB PD PE | FC | PA PB PD PE |
| SH | -4 | 122 | -20 | 50 | PA PB PD PE | | |
| DB | -4 | 212 | -20 | 100 | PA PB PD PE | | |
| JZ | 0 | 65 | -17.8 | 18.3 | PA PB PD PE | | |
| S | 0 | 100 | -17.8 | 37.8 | PA PB PD PE PF PG PW | FB | PA PB PD PE |
| JH | 0 | 120 | -17.8 | 48.9 | PA PB PD PE PF PW | FC | PA PB PD PE |
| HD | 0 | 130 | -17.8 | 54.4 | PA PB PD PE PF PW | | |
| DV | 0 | 150 | -17.8 | 65.6 | PA PB PD PE | FB | |
| EI | 0 | 160 | -17.8 | 71.1 | PA PB PD PE | | |
| AC | 0 | 200 | -17.8 | 93.3 | PA PB PD PE PW | FB NA | PA PB PD PE |
| EY | 0 | 250 | -17.8 | 121.1 | PA PB PD PE PW | NA | |
| AN | 0 | 300 | -17.8 | 148.9 | PA PB PD PE PW | FB FC NA | PA PB PD PE |
| JA | 0 | 350 | -17.8 | 176.7 | PA PB PD PE | | PA PB PD PE |
| DS | 0 | 400 | -17.8 | 204.4 | PA PB PD PE | NA | PA PB PD PE |
| AG | 0 | 500 | -17.8 | 260 | PA PB PD PE PF PW | NA | PA PB PD PE |
| QN | 0 | 550 | -17.8 | 287.8 | PA PB PD PE | | |
| AB | 0 | 600 | -17.8 | 315.6 | PA PB PD PE PF PW | NA | |
| AA | 0 | 800 | -17.8 | 426.7 | PA PB PD PE PF PW | | PA PB PD PE |
| BZ | 0 | 1000 | -17.8 | 537.8 | PA PB PD PE | | PA PB PD PE |

Temptran Temperature Ranges

Continued from previous page

| Range code | Temperature Range | | | | RTD Temptrans | | |
|------------|-------------------|---------|---------|---------|----------------------|----------------|-------------------|
| | Zero °F | Span °F | Zero °C | Span °C | TT111, TT115, TT211 | | TT321 |
| | | | | | Platinum elements | Other elements | Platinum elements |
| HU | 0 | 1300 | -17.8 | 704.4 | | | |
| BY | 14 | 104 | -10 | 40 | PA PB PD PE | | |
| AJ | 14 | 122 | -10 | 50 | PA PB PD PE | | |
| AP | 20 | 70 | -6.7 | 21.1 | PA PB PD PE PF PW | | PA PB PD PE |
| GV | 20 | 100 | -6.7 | 37.8 | PA PB PD PE PF PW | | |
| A | 20 | 120 | -6.7 | 48.9 | PA PB PD PE PF PW | FA FB FC NA | PA PB PD PE |
| HE | 20 | 240 | -6.7 | 115.6 | PA PB PD PE | | |
| AF | 20 | 320 | -6.7 | 160 | PA PB PD PE | FA FB | PA PB PD PE |
| QE | 22 | 122 | -5.6 | 50 | PA PB PD PE | | |
| GW | 23 | 131 | -5.0 | 55 | PA PB PD PE | | |
| U | 30 | 80 | -1.1 | 26.7 | PA PB PD PE PF PW | FB FC | PA PB PD PE |
| DA | 30 | 90 | -1.1 | 32.2 | PA PB PD PE PF PW | FC | |
| DP | 30 | 100 | -1.1 | 37.8 | PA PB PD PE PF PW | | |
| BI | 30 | 130 | -1.1 | 54.4 | PA PB PD PE PF PW | | PA PB PD PE |
| DQ | 30 | 150 | -1.1 | 65.6 | PA PB PD PE | FB | |
| KK | 30 | 180 | -1.1 | 82.2 | PA PB PD PE | | |
| EV | 30 | 230 | -1.1 | 110 | PA PB PD PE | | |
| BN | 30 | 240 | -1.1 | 115.6 | PA PB PD PE PF PW | FB | PA PB PD PE |
| BJ | 30 | 250 | -1.1 | 121.1 | PA PB PD PE PF PW | NA | PA PB PD PE |
| GQ | 32 | 100 | 0 | 37.8 | PA PB PD PE PF PW | | |
| EG | 32 | 104 | 0 | 40 | PA PB PD PE PF PW | | |
| N | 32 | 122 | 0 | 50 | PA PB PD PE PF PW | FB FC | |
| HL | 32 | 167 | 0 | 75 | PA PB PD PE | | |
| C | 32 | 212 | 0 | 100 | PA PB PD PE PF PW | FB FC NA | |
| QR | 32 | 257 | 0 | 125 | PA PB PD PE | | |
| DL | 32 | 280 | 0 | 137.8 | PA PB PD PE | | |
| J | 32 | 302 | 0 | 150 | PA PB PD PE PF PU PW | FC NA | PA PB PD PE |
| K | 32 | 392 | 0 | 200 | PA PB PD PE PU | NA | |
| LX | 32 | 400 | 0 | 204.4 | PA PB PD PE | | |
| BW | 32 | 482 | 0 | 250 | PA PB PD PE | NA | |
| LF | 32 | 572 | 0 | 300 | PA PB PD PE | | |
| JW | 32 | 932 | 0 | 500 | PA PB PD PE | | |
| HA | 32 | 1112 | 0 | 600 | PA PB PD PE PF PW | | |
| GF | 32 | 1472 | 0 | 800 | PA PB PD PE | | |
| SG | 33.8 | 123.8 | 1 | 51 | PA PB PD PE | | |
| H | 40 | 90 | 4.4 | 32.2 | PA PB PD PE PF PW | FB | PA PB PD PE |
| BU | 40 | 100 | 4.4 | 37.8 | PA PB PD PE PF PW | | PA PB PD PE |
| QL | 40 | 120 | 4.4 | 48.9 | PF PW | FC | |
| BK | 40 | 140 | 4.4 | 60 | PA PB PD PE PF PW | FB | PA PB PD PE |
| KH | 40 | 240 | 4.4 | 115.6 | PA PB PD PE PF PW | | |
| KP | 42 | 92 | 5.6 | 33.3 | PA PB PD PE | | |
| DU | 45 | 95 | 7.2 | 35 | PA PB PD PE | | |
| DX | 50 | 100 | 10 | 37.8 | PA PB PD PE PF PW | | PA PB PD PE |
| AH | 50 | 110 | 10 | 43.3 | PA PB PD PE | FB | |
| ED | 50 | 120 | 10 | 48.9 | PA PB PD PE PF PW | FB | |
| V | 50 | 150 | 10 | 65.6 | PA PB PD PE PF PW | FA FB NA | |
| AV | 50 | 230 | 10 | 110 | PA PB PD PE PF PW | | |
| BF | 50 | 250 | 10 | 121.1 | PA PB PD PE PF PW | | |
| AO | 50 | 300 | 10 | 148.9 | PA PB PD PE | | |
| KF | 50 | 400 | 10 | 204.4 | PA PB PD PE | | |
| D | 70 | 220 | 21.1 | 104.4 | PA PB PD PE PF PW | FB FC | PA PB PD PE |
| E | 100 | 500 | 37.8 | 260 | PA PB PD PE PF PW | | |
| BH | 122 | 302 | 50 | 150 | PA PB PD PE | | |
| BL | 200 | 500 | 93.3 | 260 | PA PB PD PE PF PW | | |



TT508/TT518 Programmable Transmitter

Amplifies an RTD signal and converts it to current

Overview

This transmitter amplifies a signal from a RTD or linear resistance, and it turns the signal into a current which increases from 4 to 20 milliamperes as the temperature or input signal increases.

This industry-standard 4-20mA signal travels thousands of feet over a pair of wires, ignoring electrical interference and bringing the temperature, accurately, into your computer or controller. Drawing power directly from the signal line, only 2 wires are needed for power and signal.

- RTD or Ohm input
- Accurate, Stable 4–20mA Output
- PC and field-programmable
- FM Approved Intrinsically Safe

Converts multiple inputs

Temperature measurement can be done with one of several RTD's: 100 Ω , 10 Ω copper, 100 Ω nickel, 120 Ω nickel, and 604, 1000, and 1000 Ω nickel-iron.

Because amplification and conversion of the input signal is performed within a few feet of the sensor, electrical interference in noisy environments is eliminated. The transmitter can be mounted at the field location in a standard DIN form B head or on a DIN rail inside a local box.

Applications

- Single temperature measurement

Configuration

The TT508/TT518 is delivered configured to the customer's specifications, including the transmitter's measurement range and RTD type.

PC Programming

The TT508/TT518 transmitter can be configured via a standard PC using a programming kit. It can be configured before installation or while installed in the process - even in hazardous areas. Communication is 2-way, so set-up and serial/tag numbers can be retrieved from the transmitter.



Specifications

Ambient temperature range: -40°C to +85°C

Supply voltage: 8 -30 VDC

Warm-up time: 5 min.

Communication interface: PC Interface/Loop Link

Signal/noise ratio: Min. 60 dB

Response time (programmable): 0.33 sec. to 60 sec.

Update time: 135 msec.

Calibration temperature: 20 to 28°C

Effect of supply voltage change: < 0.005% of span/ VDC

EMC-Immunity influence: < $\pm 0.5\%$ of span

Vibration: IEC 600 68-2-6 Test FC

Lloyd's specification no. 1: 4 g / 2 - 100 Hz

Max. wire size: AWG14 (1.5 mm²)

Air humidity: 0 - 95% RH

Dimensions: $\varnothing 1.73 \times 0.84$ in ($\varnothing 44 \times 20.2$ mm)

Tightness (enclosure/terminal): IP 68 / IP00

Weight: 50g

TT508/TT518 Programmable Transmitter

Specification and order options

Inputs (common specifications):

Max. offset: 50% of selected max. value

Cable resistance per wire (max.): 10W

Sensor current: >0.2mA, <0.4mA

Effect of sensor cable resistance: (3-wire): < 0.002 Ω/Ω

Input:

| Type | Minimum Value | Maximum Value | Minimum Span |
|-------------|---------------|---------------|--------------|
| PD (Pt100) | -200C | +850°C | 25°C |
| PF (Pt1000) | -200C | +850°C | 25°C |
| Linear Res. | 0 Ω | 10000 Ω | 30 Ω |

Basic accuracy:

PD/PF (Pt100/1000): <±0.3°C

Linear Resistance: <±0.2 Ω

Temperature coefficient:

PD/PF (Pt100/1000): <±0.01°C/°C

Linear Resistance: <±20mW/°C

Current output:

Signal range: 4 - 20 mA

Min. signal range: 16 mA

Load resistance : < (Vsup. - 8) / 0.023 [Ω]

Load stability: ± 0.01% of span / 100 Ω

Sensor error detection:

Programmable: 3.5 - 23 mA, or no action

Namur NE43 Downscale/Upscale: 3.5 mA/ 23 mA

Approvals:

EMC: EN 61326-1

ATEX.: KEMA 03ATEX1535

FM: 2D5A7

CSA: 1125003

GOST R: Yes

GOST Ex: Yes

DNV Marine: Stand. F. Certification No. 2.4

Input

The input type is selected to be one of these types:

- RTD (2 or 3-wire): PT100, PT1000

Output

The 4-20 mA output follows the TT518 input configuration, reflecting the temperature and/or resistance. The unit is protected against polarity reversal. The output signal action can be reversed with respect to the input signal. Sensor and/or cable errors can be programmed to cause the output to go to a fixed value.

Specification and order options:

| | |
|--|---|
| TT518 | Model number: TT518 approvals, fits .236" probe max TT508 approvals, fits .250" probe max |
| PD | Sensor type: PD = 100 Ω platinum RTD (0.00385) PF = 1000 Ω platinum RTD (0.00) |
| (-25/200) | Ranging: Specify temperature range in either °C or °F. For example, -25 to +200C = 4 to 20mA. |
| C | Display units: C = Celsius F = Fahrenheit |
| 1 | Calibration: 1 = Nominal 2 = Matched to sensor ±0.75% of span |
| Z | Sensor leads: (3 leads recommended) Y = 2-lead RTD (supplied with jumper wire to connect terminals 3 and 4) Z = 3-lead RTD |
| TT518PD(-25/200)C1Z = Sample part number | |

Humidity Sensors

| | |
|--|----|
| Humidity Sensor/Transmitter Assembly..... | 47 |
| Hazardous Area Humidity Assembly..... | 49 |
| Intrinsically Safe Humidity Assembly | 51 |

Humidity Sensor/Transmitter Assembly

Humidity sensing combined with an advanced microprocessor



Overview

Minco humidity and humidity/temperature transmitters are designed using an advanced microprocessor. Digital signal processing allows these transmitters to precisely match the characteristics of the humidity sensor to a wide range of RH and temperature values found in the many applications the product serves.

The humidity sensor is composed of an integrated circuit (IC) with a stable polymer element and platinum RTD that is used for temperature compensation. This sensor offers outstanding resistance to airborne contaminant and chemicals, and is protected by a sintered stainless steel filter which resists condensation.

- Wall/Duct/OSA mounting configurations
- Accuracies of $\pm 1\%$ or $\pm 2\%$ RH
- Temperature compensated
- Temperature output option
- Two-point field calibration
- NIST/SI traceable calibrations

Applications

Building environmental control systems (HVAC), hospitals, food storage, warehouses, clean rooms, pharmaceutical, freezers, drying equipment, and emissions monitoring.

Specifications

Ambient Temperature:

Operating:

Room: -10 to 150°F (-23 to 65°C), non-condensing.

Wall/Duct/OSA: -10 to 185°F (-23 to 85°C), non-condensing.

Storage:

Room: -58 to 150°F (-50 to 65°C), non-condensing.

Wall/Duct/OSA: -58 to 185°F (-50 to 85°C), non-condensing.

Supply voltage: 9.5 to 35 VDC, non-polarized.

Voltage effect: $\pm 0.001\%$ of span/volt from 9.5 to 35 VDC.

Loop resistance: The maximum allowable resistance of the signal-carrying loop, including extension wires and load resistors, is given by this formula: $R_{loopmax} = (V_{supply} - 9.5) / 0.02 \text{ AMPS}$. For example, if supply voltage is 24 VDC, the loop resistance must be less than 725 Ω .

Adjustments: Zero and span field adjustments, non-interacting.

Time Constant: 50 seconds in slow moving air.

Connections: Screw terminals (22-14 AWG wire).

Weight:

Room: 0.19 lb (.084 kg).

Wall/Duct/OSA: 1.20 lb (0.55 kg).

Minimum output current: 3.5 mA

Maximum output current: 23 mA.

Humidity Sensor/Transmitter Assembly

Technical details and specifications

Humidity Transmitter AH429 and AH439

Output: 4-20 mA DC = 0% to 100% RH.

Sensing Element: Capacitive monolithic IC.

Accuracy: Includes temperature, linearity, hysteresis, and repeatability.

±1% from 10% to 80% RH @ 25 to 35°C or

±2% from 0% to 90% RH @ 25°C

(±3% from 0% to 90% RH @ 15 to 50°C)

(±5% from 0% to 90% RH @ 0 to 82°C)

Temperature Transmitter (AH439 only)

Output: 4-20 mA DC over the specified temperature range.

Specification and order options

| AH429 | Model number |
|--|---|
| R | Enclosure D: Duct mount, 8" probe length O: Outside Air/Wall mount, 4" probe length with shield, weather resistant enclosure S: Space mount W: Wall mount, 4" probe length, weather resistant enclosure R: Remote probe, 4" probe length |
| | 1 Outputs: 4 to 20 mA DC |
| | N10 Calibration accuracy (humidity transmitter) N10: ±1% from 10% to 80% (25 to 35°C) with NIST/SI certificate N20: ±2% from 0% to 90% (25 to 35°C) with NIST/SI certificate S20: ±2% from 0% to 90% (25 to 35°C) |
| | T1 Sensing element cover (omitted on "S" space mount models) T0= Sintered stainless steel; pressed on cover T1= Sintered stainless steel; screw on cover T2= Slotted stainless steel; screw on cover (NA on "O" outside air models) |
| To order enclosure D, O, S or W, stop here. To order enclosure R (remote probe), add: | |
| A | Probe mounting location A = Side mounting B = Bottom mounting |
| 48 | Remote probe cable length (in inches) 48" and 96" are standard lengths |
| AH429R1N10T1A48 = Sample part number | |

Sensing element: 1000 Ω platinum; 2 lead resistance thermometer, 0.00385 TCR.

Accuracy: Includes resistance thermometer tolerance, calibration accuracy, linearity, and ambient temperature effects.

±.75% of Temptran span for 32 to 122°F ambient.

±1.50% of Temptran span for -13 to 185°F ambient.

Specification and order options

| AH439 | Model number | |
|---------------------------------------|---|--|
| D | Enclosure D: Duct mount, 8" probe length O: Outside Air/Wall mount, 4" probe length with shield, weather resistant enclosure S: Space mount W: Wall mount, 4" probe length, weather resistant enclosure R: Remote probe, 4" probe length | |
| | 1 Outputs: 4 to 20 mA DC | |
| | N10 Calibration accuracy (humidity transmitter) N10: ±1% from 10% to 80% (25 to 35°C) with NIST/SI certificate N20: ±2% from 0% to 90% (25 to 35°C) with NIST/SI certificate S20: ±2% from 0% to 90% (25 to 35°C) | |
| | A Temperature transmitter range EN: -20°F to 140°F S: 0°F to 100°F A: 20°F to 120°F Bl: 30°F to 130°F KK: 30°F to 180°F N: 32°F to 122°F H: 40°F to 90°F <i>See pages 42-43 or visit minco.com for additional temperature range codes.</i> | |
| T1 | Sensing element cover (omitted on "S" space mount models) T0= Sintered stainless steel; pressed-on cover T1= Sintered stainless steel; screw-on cover T2= Slotted stainless steel; screw-on cover (NA on "O" outside air models) | |
| | To order enclosure D, O, S or W, stop here. To order enclosure R (remote probe), add: | |
| | A | Probe mounting location A = Side mounting B = Bottom mounting |
| | 48 | Remote probe cable length (in inches) 48" and 96" are standard lengths |
| AH439D1N10AT1A48 = Sample part number | | |

Hazardous Area Humidity Sensors

Temperature-compensated humidity transmitter



Overview

Models AH71_, AH72_, and AH73_ series are 2-wire temperature compensated humidity transmitters that are FM and CFM approved for use in hazardous locations. Intrinsically safe models are available with an optional temperature transmitter output. The AH73 is also available with an optional digital display for remote indication of relative humidity and temperature.

The transmitters utilize a thin film capacitive humidity sensor which provides outstanding sensitivity and chemical robustness. The transmitter converts the humidity sensor's signal into a 4 to 20 mA DC current, which changes proportionally from 4 mA at 0% RH to 20 mA at 100% RH. The optional temperature loop produces a second 4 to 20 mA DC output where the current changes from 4 mA at the lowest temperature of the range, to 20 mA at the top of the temperature range. The leads that supply power also carry the current signal.

- Accuracy of $\pm 2.5\%$ RH
- Temperature compensated
- Temperature output option
- Two-point field calibration
- NIST/SI traceable calibrations

Applications

Building automation systems (HVAC), hospitals, food storage, warehouses, clean rooms, pharmaceutical, drying equipment, and emissions monitoring.

Technical Details

Output(s):

Humidity: 4 to 20 mA DC = 0% to 100% RH.

Temperature: 4 to 20 mA DC over specified range (optional)

Humidity Range: 0 – 100% RH

Sensing Element:

Humidity: Thin film capacitive element.

Temperature: 1000 Ω platinum RTD, 0.00385 TCR

Temperature Effect: $\pm 0.03\%$ RH/ $^{\circ}\text{C}$ $\pm 1\%$ from 10 $^{\circ}\text{C}$ to 85 $^{\circ}\text{C}$

Operating Temperature:

Transmitter:

-40 to 176 $^{\circ}\text{F}$ (-40 to 80 $^{\circ}\text{C}$), non-condensing.

-4 to 176 $^{\circ}\text{F}$ (-20 to 80 $^{\circ}\text{C}$), non-condensing, model AH73.

Sensor:

-40 to 302 $^{\circ}\text{F}$ (-40 to 150 $^{\circ}\text{C}$).

Storage Temperature:

-58 to 185 $^{\circ}\text{F}$ (-50 to 85 $^{\circ}\text{C}$), non-condensing.

Supply voltage:

9.5 to 28 VDC for intrinsically safe (IS) models.

16.5 to 28 VDC for explosionproof (XP) models.

Voltage effect: $\pm 0.001\%$ of span/volt from 9.5 to 28 VDC.

Loop resistance: The maximum allowable resistance of the signal-carrying loop, including extension wires and load resistors, is given by this formula:

IS: $R_{\text{loopmax}} = (V_{\text{supply}} - 9.5) / 0.02 \text{ AMPS}$. For example, if supply voltage is 24 VDC, the loop resistance must be less than 725 Ω .

XP: $R_{\text{loopmax}} = (V_{\text{supply}} - 16.5) / 0.02 \text{ AMPS}$. For example, if supply voltage is 24 VDC, the loop resistance must be less than 375 Ω .

Accuracy: Includes linearity, hysteresis, repeatability, and voltage effects.

Humidity: $\pm 2.5\%$ from 10% to 80% RH @ 25 $^{\circ}\text{C}$, $\pm 3.5\%$ from 80% to 90% RH @ 25 $^{\circ}\text{C}$.

Temperature: $\pm 0.5^{\circ}\text{F}$ (0.27 $^{\circ}\text{C}$) @ 77 $^{\circ}\text{F}$ (25 $^{\circ}\text{C}$) or $\pm 0.75\%$ of span, whichever is greater.

Hazardous Area Humidity Sensors

Technical details and specifications

Adjustments: Zero and Span field adjustments, non-interacting.

Time Constant: 50 seconds in slow moving air.

Connections: Screw terminals (22-14 AWG wire).

Weight:

AH72_, AH73_ 4.46 lbs (2.02 kg).

Min. output current: 3.8 mA.

Max. output current: 22 mA.

Filter: 60 micron stainless-steel sintered filter (replacement P/N : AC103512)

Factory Mutual Approvals:

Explosionproof with intrinsically safe sensor:

Suitable for the following hazardous area locations:

- Class I, Division 1, 2, Groups B, C, D
- Class II, Division 1, 2, Groups E, F, G
- Class III, Division 1, 2

Intrinsically safe installation:

Suitable for the following hazardous area locations:

- Class I, Division 1, 2, Groups A, B, C, D
- Class II, Division 1, 2, Groups E, F, G
- Class III, Division 1, 2
- Class I, Zone 0, AEx ia IIC T4

Non-Incendive:

Suitable for the following hazardous area locations:

- Class I, Division 2, Groups A, B, C, D
- Class II, Division 2, Groups F, G
- Class III, Division 2

Transmitter entity parameters:

Vmax = 28 volts; Imax = 100 mA; Ci = 0.037 mF and Li = 0 mH.

Accessories:

Sintered Filter Replacement Part Number: **AC103512**

Slotted Filter Replacement Part Number: **AC103513**

Pipe Mounting Kit for AH72/AH73 Part Number: **AC102765**

Wall Mounting Kit for AH71 Part Number: **AC103168**

Duct Mounting Kit for AH71 Part Number: **AC103253**

| Code | Transmitter range |
|------|----------------------------|
| NT | No temperature transmitter |
| EN | -20°F to 140°F |
| S | 0°F to 100°F |
| A | 20°F to 120°F |
| BI | 30°F to 130°F |
| KK | 30°F to 180°F |
| N | 32°F to 122°F |
| H | 40°F to 90°F |

Specification and order options

| | | | |
|---|---|-------------------------------------|-------------|
| AH73 | Model number AH71 Industrial grade humidity transmitter with optional temperature transmitter, CH106 connection head, display NA AH72 Industrial grade humidity transmitter with optional temperature transmitter, connection head, display NA AH73 Industrial grade humidity transmitter with optional temperature transmitter, connection head, display available | | |
| | 1 | Probe diameter 1 = 0.375" | |
| P3 | Pipe thread code | | |
| | Code | Process | Conduit |
| | P3 | 1/2 - 14NPT | 1/2 - 14NPT |
| | P4 | 1/2 - 14NPT | 3/4 - 14NPT |
| | P5 | G 1/2 A | 1/2 - 14NPT |
| L120 | P6 | G 1/2 A | 3/4 - 14NPT |
| | Probe length L60 = 6" L120 = 12" | | |
| T1 | Filter type T1 = Sintered stainless steel T2 = Slotted stainless steel | | |
| HT490 | Transmitter model number HT480 = Explosionproof with intrinsically safe sensor (transmitter code NT only) HT490 = Intrinsically safe | | |
| F | Display C = Display, metric units (AH73_series only) F = Display, English units (AH73_series only) N = No display (AH71_ and AH72_ series only) | | |
| 1 | Signal output 1 = 4 to 20mA | | |
| N25 | Calibration accuracy (humidity transmitter) N25 ±2.5% from 10% to 80% (25°C) with NIST/SI certificate S25: ±2.5% from 10% to 80% (25°C) | | |
| EN | Temperature transmitter range from table; additional ranges on pages 42-43. | | |
| AH731P3L120T1HT490F1N25EN = Sample part number | | | |

Intrinsically Safe Humidity Sensors

Temperature-compensated humidity transmitters



Overview

Models AH74 and AH75 are 2-wire temperature compensated humidity transmitters that are FM and CFM approved as intrinsically safe for use in hazardous locations. Both models are available with an optional temperature transmitter output. AH75 incorporates a digital display for remote indication of relative humidity and temperature.

The transmitters utilize a thin film capacitive humidity sensor which provides outstanding sensitivity and chemical robustness. The transmitter converts the humidity sensor's signal into a 4 to 20 mA DC current, which changes proportionally from 4 mA at 0% RH to 20 mA at 100% RH. The optional temperature loop produces a second 4 to 20 mA DC output where the current changes from 4 mA at the lowest temperature of the range, to 20 mA at the top of the temperature range. The leads that supply power also carry the current signal.

- Accuracy of $\pm 2.5\%$ RH
- Temperature compensated
- Temperature output option
- Two-point field calibration
- NIST/SI traceable calibrations

Applications

Building automation systems (HVAC), hospitals, food storage, warehouses, clean rooms, pharmaceutical, drying equipment, and emissions monitoring.

Technical Details

Output(s):

Humidity: 4 to 20 mA DC = 0% to 100% RH.

Temperature: 4 to 20 mA DC over specified range (optional).

Humidity Range: 0 – 100% RH

Sensing Element:

Humidity: Thin film capacitive element.

Temperature: 1000 Ω platinum RTD.

Temperature Effect: $\pm 0.03\%$ RH/ $^{\circ}\text{C}$ $\pm 1\%$ from 10 $^{\circ}\text{C}$ to 85 $^{\circ}\text{C}$

Operating Temperature:

Transmitter:

-40 to 176 $^{\circ}\text{F}$ (-40 to 80 $^{\circ}\text{C}$), non-condensing.

-4 to 176 $^{\circ}\text{F}$ (-20 to 80 $^{\circ}\text{C}$), non-condensing, model AH75.

Sensor:

-40 to 176 $^{\circ}\text{F}$ (-40 to 80 $^{\circ}\text{C}$),

Storage Temperature:

-58 to 185 $^{\circ}\text{F}$ (-50 to 85 $^{\circ}\text{C}$), non-condensing.

Supply voltage: 9.5 to 28 VDC .

Voltage effect: $\pm 0.001\%$ of span/volt from 9.5 to 28 VDC.

Loop resistance: The maximum allowable resistance of the signal-carrying loop, including extension wires and load resistors, is given by this formula: $R_{loopmax} = (V_{supply} - 9.5) / 0.02 \text{ AMPS}$.

Accuracy: Includes linearity, hysteresis, repeatability, and voltage effects.

Humidity: $\pm 2.5\%$ from 10% to 80% RH @ 25 $^{\circ}\text{C}$, $\pm 3.5\%$ from 80% to 90% RH @ 25 $^{\circ}\text{C}$.

Temperature: $\pm 0.5^{\circ}\text{F}$ (0.27 $^{\circ}\text{C}$) @ 77 $^{\circ}\text{F}$ (25 $^{\circ}\text{C}$) or $\pm 0.75\%$ of span, whichever is greater.

Adjustments: Zero and Span field adjustments, non-interacting.

Time Constant: 50 seconds in slow moving air.

Connections: Screw terminals (22-14 AWG wire).

Weight:

AH74 0.54 lbs (245 g).

AH75 0.61 lbs (276 g).

Min. output current: 3.8 mA.

Max. output current: 22 mA.

Filter: 60 micron stainless-steel sintered filter (replacement P/N : AC103512)

Factory Mutual Approvals:

Intrinsically safe:

Suitable for the following hazardous area locations:

Class I, Division 1, Groups A, B, C, D

Class I, Zone 0, AEx ia IIC T4

Non-Incendive:

Suitable for the following hazardous area locations:

Class I, Division 2, Groups A, B, C, D

Transmitter entity parameters:

$V_{max} = 28\text{v}$; $I_{max} = 100 \text{ mA}$; $C_i = 0.037 \text{ mF}$ and $L_i = 0 \text{ mH}$.

Intrinsically Safe Humidity Sensors

Specifications and order options

Specification and order options

| | |
|--|---|
| AH75 | Model Number: AH74 - Humidity Transmitter with Optional Temperature Transmitter, No Display AH75 - Humidity Transmitter with Optional Temperature Transmitter, with Display |
| 1 | Probe Diameter: 1 - 0.375" |
| C3 | Probe Location / Cable Bushings Option: Please refer to dimensional drawings for probe Location. C1 = Probe Location A (Rear) / Single Cable Gland C2 = Probe Location A (Rear) / Dual Cable Glands C3 = Probe Location A (Rear) / Single Conduit Fitting, 1/2" NPT C4 = Probe Location A (Rear) / Dual Conduit Fittings, 1/2" NPT C5 = Probe Location B (Bottom) / Single Cable Gland C6 = Probe Location B (Bottom) / Dual Cable Glands C7 = Probe Location B (Bottom) / Single Conduit Fitting, 1/2" NPT C8 = Probe Location B (Bottom) / Dual Conduit Fittings, 1/2" NPT <i>Note: If a temperature loop is desired, dual cable glands or dual conduit fittings must be selected unless special cable is used during installation. Please refer to National Electrical Code ANSI/NFPA 70 for installation in accordance with US requirements, or Canadian Electrical Code, C22.1 for installation in accordance with Canadian requirements.</i> |
| L40 | Probe Length: L40 = 4" |
| T1 | Filter Type: T1 = Sintered Stainless Steel T2 = Slotted Stainless Steel |
| HT490 | Transmitter Model Number: HT490 = Intrinsically Safe Transmitter |
| F | Display: C = Display, Metric Units (AH75_ Series Only) F = Display, English Units (AH75_ Series Only) N = No Display |
| 1 | Signal Output: 4-20mA |
| N25 | Calibration Accuracy: N25 = ±2.5% from 10% to 80% (25°C) with NIST/SI Certificate S25 = ±2.5% from 10% to 80% (25°C) |
| NT | Temperature Transmitter Range from table below; additional ranges on pages 42-43. |
| AH751C3L40T1HT490F1N25NT = Sample part number | |

Probe Location A

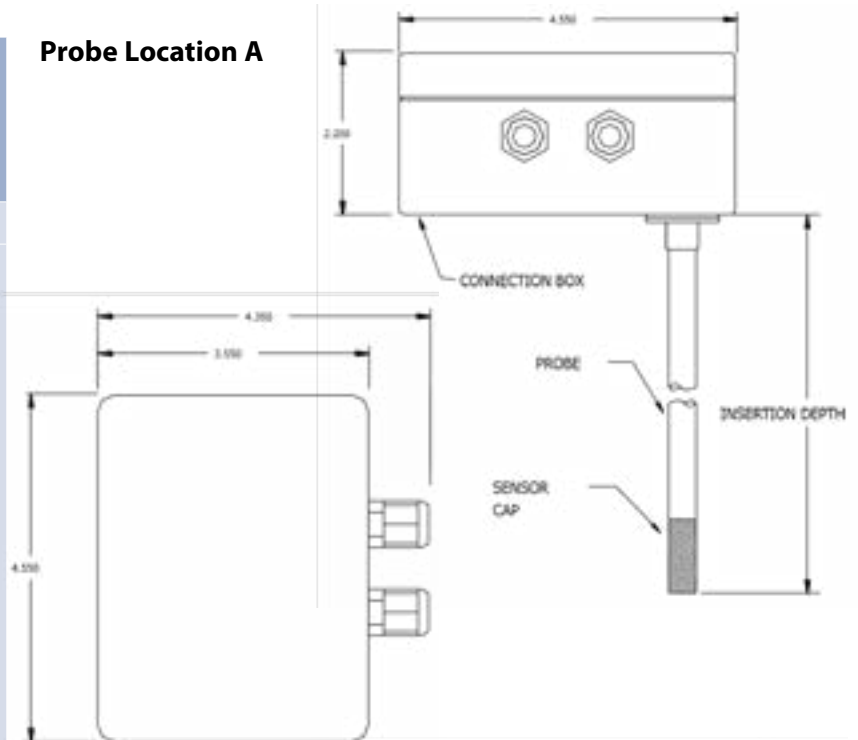

Probe Location B

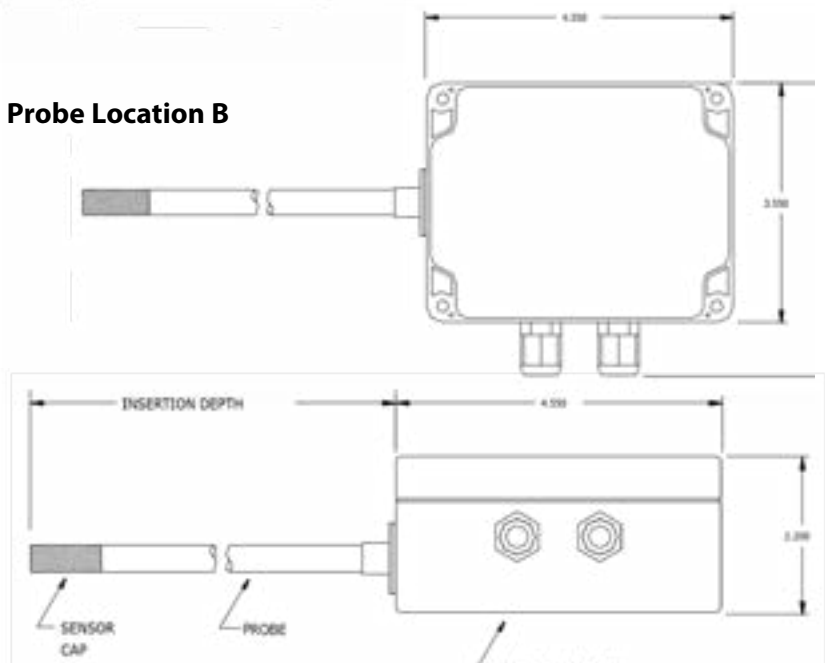

| Code | NT | EN | S | A | BI | KK | N | H |
|--------------------------|----------------------------|----------------|--------------|---------------|---------------|---------------|---------------|--------------|
| Transmitter range | No temperature transmitter | -20°F to 140°F | 0°F to 100°F | 20°F to 120°F | 30°F to 130°F | 30°F to 180°F | 32°F to 122°F | 40°F to 90°F |

Conductivity Level Sensor

| | |
|--------------------------------|----|
| Conductivity Level Sensor..... | 54 |
|--------------------------------|----|

Conductivity Level Sensor

Detects nearly any conductive fluid



Overview

The LT364 Level Sensor provides point fluid detection with virtually any conductive fluid. Two 316 stainless steel pins provide for operation in mildly corrosive fluids within plastic or metal containers. Fluid presence is measured by passing a low voltage AC signal between the stainless steel probes. The use of an AC voltage eliminates the effects of galvanic corrosion on the probes. Power to the sensor and output from the sensor is derived from a current loop. Sensor output is 8 mA with fluid present and 16 mA with no fluid present.

- No calibration necessary.
- Injection molded, high-temperature plastic case.
- Electronics can be used in applications with an ambient temperature up to 185°F (85°C).
- Connection is made using an industry-standard
- Packard/Delphi Metri-pack 150 connector providing an easy-to-connect, polarized connection.

Application Ideas

- Radiator low-fluid level detection
- Pump recovery tanks
- Fluid leak detection
- Parts washers
- Automated test equipment

Specifications

Sensor Output:

8 mA \pm 1 mA with fluid present and 16 mA \pm 1 mA with no fluid present

Ambient Temperature (electronics):

Operation: -40 to 185°F, non-condensing
Storage: -67 to 212°F, non-condensing

Supply Voltage: 7.6 to 35VDC, reverse polarity protected

Loop resistance: Maximum allowable resistance of the signal-carrying loop, including wires and load resistors given by:
 $R_{loopmax} = (V_{supply} - 7.6) / .02 \text{Amps}$

Voltage Stability: Change in loop current $< \pm 0.01$ mA from 7.6 to 35 VDC

Sensor Housing: 3/8 - 18 NPT process thread, nylon with 30% glass plastic encapsulation; end connector is Packard/Delphi Metri-pack 150.

Weight: Approximately 2.5 oz (70 g)

Specification and order options

| LT364 | Model number |
|-------|---|
| | Pin length in inches 015 = 1.5 inches |
| L015 | Variable lengths are available. Contact Minco to learn more about custom design options for your application. |

LT364L015 = Sample part number

LT364 Mating Cable Assembly

- 72" shielded cable
- 2-conductor, AWG #18, copper braid shield with drain wire
- Terminated with a female Metri-pack 150 connector

Specification and order options

| AC203350 | Model number from table |
|----------|-------------------------|
| L72 | 72" lead length |

AC203350L72 = Sample part number

Conductivity Level Sensor

Dimensional drawings

Wiring Diagram

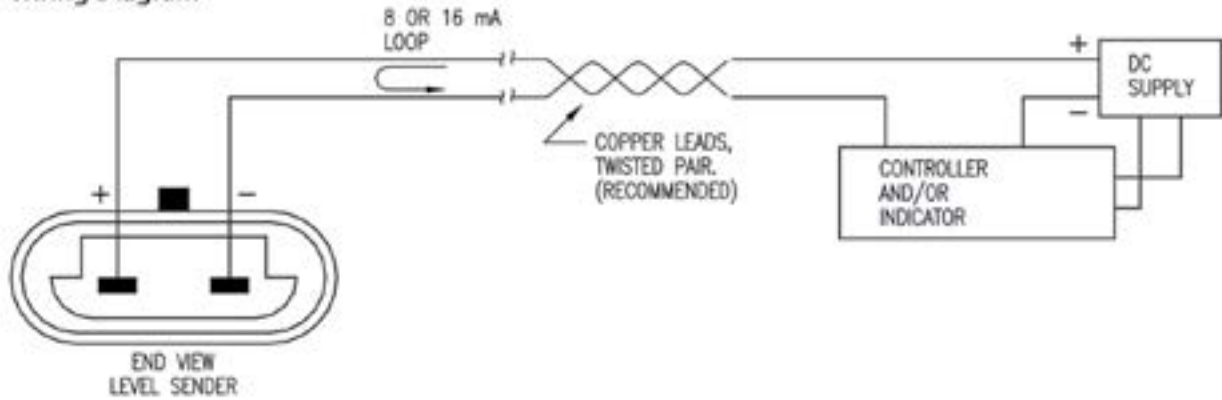

Dimensional Drawings

Side View

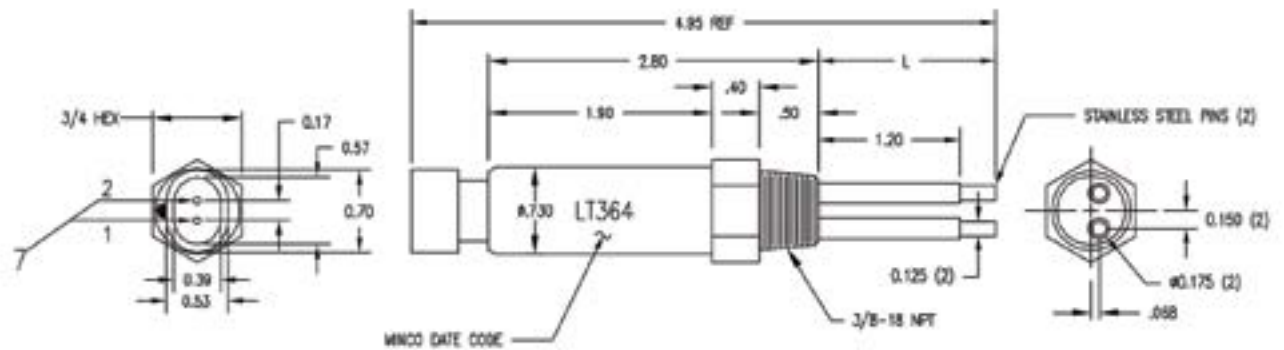

Connection End

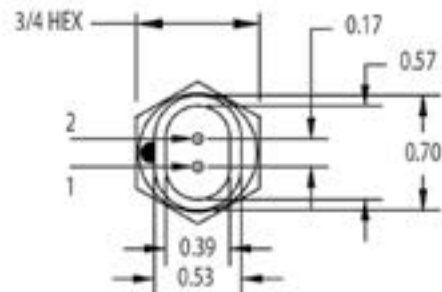

Measurement End

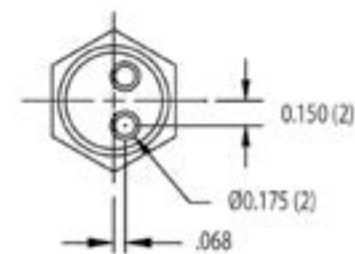

Accessories

| | |
|------------------------------------|----|
| Fluid Immersion Fittings | 57 |
| Economy and HVAC Thermowells | 58 |
| Connection Heads | 59 |
| Extension Wire | 60 |

Fluid Immersion Fittings



Install probes directly into fluid streams

Overview



Install probes directly into fluid streams and pressure vessels. Simply position the fitting on the probe and tighten the sealing nut.

Fluid seal fittings are best for moderate temperatures and pressures. Pressure fittings, constructed of stainless steel, can withstand corrosive media and greater extremes of pressure and temperature.

Fluid seal fittings to 260C (500F)

| | Body material | Thread "CH" | Process thread | Adder "A" (total length) | Probe inch Ø (mm) | Model |
|--|-----------------|--------------|----------------|--------------------------|-------------------|-------|
|  | Brass | None | 1/8 - 27 NPT | 1.2" min (31 mm) | 0.188 (4.8) | FG143 |
| | | None | 1/4 - 18 NPT | | | FG140 |
| | | None | 1/8 - 27 NPT | | 0.215 (5.5) | FG126 |
| | | None | 1/4 - 18 NPT | | | FG120 |
| | | None | 1/8 - 27 NPT | | 0.250 (6.4) | FG151 |
| | | None | 1/4 - 18 NPT | | | FG130 |
|  | Stainless steel | 1/2 - 14 NPT | 1/2 - 14 NPT | 2.4" (61 mm) | 0.188 (4.8) | FG142 |
| | | | | | 0.215 (5.5) | FG122 |
| | | | | | 0.250 (6.4) | FG132 |

Fluid seal fittings to 260C (500F)

| | Body material | Thread "CH" | Process thread | Adder "A" (total length) | Probe inch Ø (mm) | Model | | | |
|---|---------------------|---|---------------------|--------------------------|-------------------|--------------|--------------|-------------|---------|
|  | 316 stainless steel | None | 1/8 - 27 NPT | 1.5" min (39 mm) | 0.188 (4.8) | FG141T3P2 | | | |
| | | None | 1/4 - 18 NPT | | | FG141T3P4 | | | |
| | | None | 1/8 - 27 NPT | | 0.215 (5.5) | FG141T3P8 | | | |
| | | None | 1/4 - 18 NPT | | | FG141T4P2 | | | |
| | | None | 1/8 - 27 NPT | | 0.250 (6.4) | FG141T4P4 | | | |
| | | None | 1/4 - 18 NPT | | | FG141T4P8 | | | |
| | |  | 316 stainless steel | | 1/2 - 14 NPT | 1/2 - 14 NPT | 2.9" (74 mm) | 0.125 (3.2) | FG145T2 |
| | | | | | | | | 0.188 (4.8) | FG145T3 |
| | | | | | | | | 0.250 (6.4) | FG132T4 |

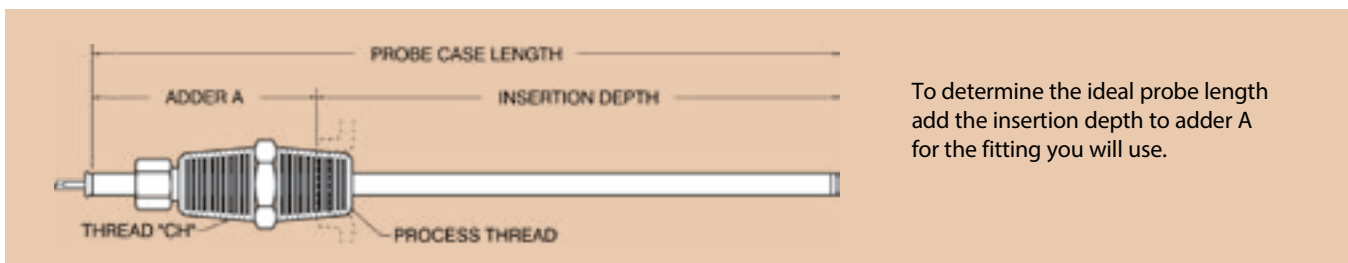

To determine the ideal probe length add the insertion depth to adder A for the fitting you will use.

Economy and HVAC Thermowells

Protect probes from pressure, flow, and corrosion



Overview

Thermowells protect probes from pressure, flow, and corrosion. The models on this page have integral fittings for probe and connection head mounting.

Immerse the thermowell at least 2.5" (65 mm) for accurate readings. The well should extend beyond the center of the fluid stream without touching the opposite wall. Installation in an elbow or tee may be necessary for sufficient immersion in small pipes.

For fastest time response, Minco can furnish thermowells with heat sink compound in the tip. This eliminates the air gap between the probe and inside wall of the well and can reduce time constant by as much as 50%. Order AC101750.

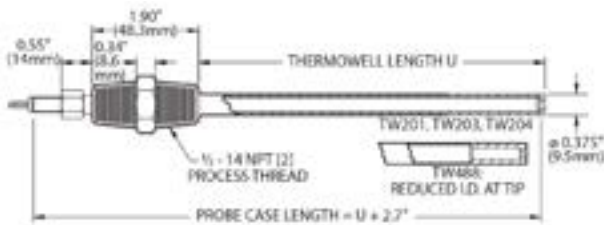

Economy thermowell specifications

Models: TW204 / TW201 / TW203

Probes: Use with tip-sensitive probes, available on Minco.com.

Body material: 300 series stainless steel, nickel-plated brass sealing nut with brass compression ring

Temperature limit: 260°C (500°F)

Pressure rating: 1000 psi (69.9) bar

Hex size: 7/8" (22 mm)

Standard U dimension: 0.1" increments to 48"

| Probe diameter | Thread "CH" | Process Thread | Model |
|-----------------|-------------|----------------|-------|
| 0.188" (4.8mm) | | | TW204 |
| 0.215" (5.5mm) | 1/2-14 NPT | 1/2-14 NPT | TW201 |
| 0.250" (6.4 mm) | | | TW203 |

HVAC thermowell specifications

Model: TW488

Probes: Use with HVAC probes on page 20.

Body material: 316 stainless steel, nickel-plated brass sealing nut with silicone rubber O-ring

Temperature limit: 260°C (500°F)

Pressure rating: 1880 psi (129.7) bar

Hex size: 7/8" (22 mm)

Standard U dimension: 3.0, 6.0, 12.0, and 18.0". Other lengths are available

| Probe diameter | Thread "CH" | Process Thread | Model |
|-----------------|-------------|----------------|-------|
| 0.250" (6.4 mm) | 1/2-14 NPT | 1/2-14 NPT | TW488 |

Specification and order options

| TW203 | Model number |
|-------------------------------|---|
| U | |
| 60 | Thermowell length U: Specify in 0.1" increments (Ex: 60 = 6.0 inches) |
| TW203U60 = Sample part number | |

Connection Heads

Protect vital sensing equipment with durable connection heads

| Dimensions in inches (mm) | | Body/gasket | IP/NEMA Rating | Max Temp. | Pipe thread and terminal options | Temptran™ models | Approx. weight | Model |
|---|--|---|-----------------------|----------------|--|-----------------------------------|--------------------|-------|
| CH103 3.5 (89) H 3.5 (89) L 1.9 (48) D 1.9 (48) T | | Nickel-plated cast iron with SS chain/silicone gasket | IP55 Type 3 and 4 | 316°C* (600°F) | P1, P2, P3, P4 T0, T6, T8 W0, W6 | All models except TT220 and TT221 | 2.0 lbs. (0.9 kg.) | CH103 |
| CH366 3.0 (76) H 3.7 (94) L 1.37 (35) D 1.9 (48) T | | White polypropylene (FDA approved)/neoprene gasket | IP55 Type 3 and 4 | 110°C (230°F) | P3 only T0, T6, T8 W0 | All models except TT220 and TT221 | 0.2 lbs. (0.1 kg.) | CH366 |
| CH359 3.5 (89) H 3.5 (89) L 2.0 (51) D 1.75 (44) T | | Aluminum/silicone gasket | IP55 Type 3 and 4 | 316°C* (600°F) | P1, P2, P3, P4 T0, T6, T8 W0, W6 | All models except TT220 and TT221 | 0.8 lbs. (0.4 kg.) | CH359 |
| CH301 2.33 (59.2) H 4.25 (108) L 1.25 (31.8) D 3.60 (91.4) T | | Aluminum/neoprene gasket | IP55 Type 3 and 4 | 115°C (240°F) | CH301: P3 only T0, T6, T8 W0, W4, W6 | Miniature TT111 and TT211 models | 0.5 lbs. (0.2 kg.) | CH301 |
| CH302: P2 only T0, T6, T8 W0, W4, W6 | | | | | CH302 | | | |
| CH360 3.5 (89) H 3.5 (89) L 2.0 (51) D 1.75 (44) T | | 316 SS with silicone gasket | IP56 Type 3, 4 and 4x | 316°C* (600°F) | P1, P2, P3, P4 T0, T6, T8 W0, W6 | All models except TT220 and TT221 | 1.8 lbs. (0.8 kg.) | CH360 |

Specification and order options

| | | | |
|--------------------------------|--|-----------------|-----------------|
| CH104 | Model number from table | | |
| P2 | Pipe thread code: | Thread A | Thread B |
| | P1 | ¾ - 14 | ½ - 14 |
| | P2 | ¾ - 14 | ¾ - 14 |
| | P3 | ½ - 14 | ½ - 14 |
| T | Connection type: | | |
| | T = Terminal board for wires AWG 14 or smaller W = Wire nuts for wires AWG 14 to 22 | | |
| 6 | Number of terminal posts or wire nuts: | | |
| | 0, 4, 6 or 8 (see available options) T0: transmitter mounting hardware W0: empty enclosure | | |
| CH104P2T6 = Sample part number | | | |

Extension Wire

Connect sensor leadwires to remote instrumentation

Overview

Use extension wire and cable to connect sensor leadwires to remote instrumentation. Unless informed otherwise, wire and cable will be supplied in continuous lengths. Ends are not stripped.



Wire for RTDs

Choose single conductor copper wire or cable.

| Description | Temp. Limit | Color | Model Number for AWG | |
|--|----------------|------------------------------------|----------------------|--------|
| | | | 22 | 26 |
| Single-conductor wire, stranded, PTFE insulation | 260°C (500°F) | White | WS122W | WS126W |
| | | Red | WS122R | WS126R |
| | | Blue | WS122B | WS126B |
| | | Yellow | WS122Y | WS126Y |
| Single-conductor wire, stranded, mica/glass insulation | 550°C (1022°F) | White | WS222W | |
| | | Red tracer | WS222R | |
| 3-conductor cable, PTFE insulation, stainless steel braid over all | 260°C (500°F) | Red/White/White | WS322S | WS326S |
| 6-conductor cable, PTFE insulation, stainless steel braid over all | 260°C (500°F) | Red/White/White/Blue/Yellow/Yellow | | WS426S |
| 3-conductor cable, PTFE insulation, copper shield and PTFE jacket over all | 260°C (500°F) | Red/White/White | WS522T | |

Specification and order options

| | |
|-------------------------------|----------------|
| WS122R | Model number |
| 10 | Length in feet |
| WS122R10 = Sample part number | |

Single Pair Thermocouple Cable

All thermocouple wire meets standard limits of error per NBS (NIST/SI) Monograph 175, based on ITS-90.

| Description | Temperature Limit | Model Number for AWG | |
|--|-------------------|----------------------|--------|
| | | 20 | 24 |
| Single pair thermocouple cable, glass braid insulation | 482°C (900°F) | WT120G | WT124G |
| Single pair thermocouple cable, PTFE insulation | 260°C (500°F) | WT120T | WT124T |
| Single pair thermocouple cable, glass braid insulation with stainless steel braid over all | 482°C (900°F) | WT120S | WT124S |

Specification and order options

| | |
|--------------------------------|--|
| WT120S | Model number |
| J | <u>Junction type:</u> E, J, K, or T |
| 10 | Length in feet |
| WS120SJ10 = Sample part number | |